

KENWOOD

AUDIO VIDEO SURROUND RECEIVER

1070VR
1060VR

INSTRUCTION MANUAL

KENWOOD CORPORATION

This manual contains instructions for two models.
Model availability and features (functions) may differ depending on country and sales area.

About the supplied remote control . . .

Compared to standard remote controls, the remote control supplied with this receiver has several operation modes. These modes enable the remote control to control other audio/video components. In order to effectively use the remote control it is important to read the operating instructions and obtain a proper understanding of the remote control and how to switch its operation modes (etc.).

Using the remote control without completely understanding its design and how to switch the operation modes may result in incorrect operations.

Before applying the power

Units are designed for operation as follows.

U.S.A. and Canada AC 120 V only
 *Other countries AC 110-120 / 220-240 V switchable

* AC voltage selection

The AC voltage selector switch on the rear panel is set to the voltage that prevails in the area to which the unit is shipped. Before connecting the power cord to your AC outlet, make sure that the setting position of this switch matches your line voltage. If not, it must be set to your voltage in accordance with the following direction.

Note:
 Our warranty does not cover damage caused by excessive line voltage due to improper setting of the AC voltage selector switch.

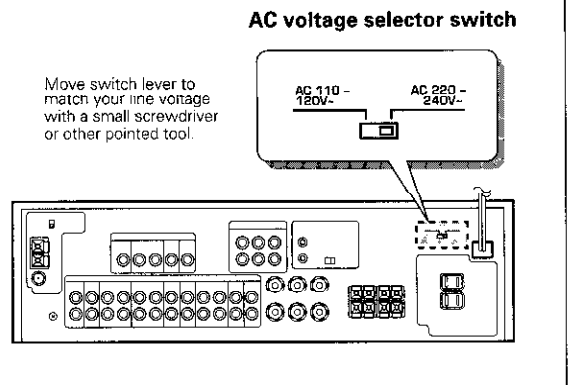

Safety precautions

WARNING : TO PREVENT FIRE OR ELECTRIC SHOCK, DO NOT EXPOSE THIS APPLIANCE TO RAIN OR MOISTURE.

	CAUTION RISK OF ELECTRIC SHOCK DO NOT OPEN		CAUTION: TO REDUCE THE RISK OF ELECTRIC SHOCK, DO NOT REMOVE COVER (OR BACK). NO USER-SERVICEABLE PARTS INSIDE, REFER SERVICING TO QUALIFIED SERVICE PERSONNEL.
	THE LIGHTNING FLASH WITH ARROWHEAD SYMBOL, WITHIN AN EQUILATERAL TRIANGLE, IS INTENDED TO ALERT THE USER TO THE PRESENCE OF UNINSULATED "DANGEROUS VOLTAGE" WITHIN THE PRODUCT'S ENCLOSURE THAT MAY BE OF SUFFICIENT MAGNITUDE TO CONSTITUTE A RISK OF ELECTRIC SHOCK TO PERSONS.		
	THE EXCLAMATION POINT WITHIN AN EQUILATERAL TRIANGLE IS INTENDED TO ALERT THE USER TO THE PRESENCE OF IMPORTANT OPERATING AND MAINTENANCE (SERVICING) INSTRUCTIONS IN THE LITERATURE ACCOMPANYING THE APPLIANCE.		

Unpacking



Unpack the unit carefully and make sure that all accessories are put aside so they will not be lost. Examine the unit for any possibility of shipping damage. If your unit is damaged or fails to operate, notify your dealer immediately. If your unit was shipped to you directly, notify the shipping company without delay. Only the consignee (the person or company receiving the unit) can file a claim against the carrier for shipping damage. We recommend that you retain the original carton and packing materials for use should you transport or ship the unit in the future.

Accessories

FM indoor antenna (1)	AM loop antenna (1)	Loop antenna stand (1)	Remote control unit (1)
Batteries (R03/AAA) (4)			

Contents

Caution : Read the pages marked  carefully to ensure safe operation.

Getting started	2
 Before applying the power	2
 Safety precautions	2
Unpacking	2
Special features	4
How to use this manual	5
Names and functions of parts	6
Setting up the system	8
Connecting the antennas	8
FM DE-EMPHASIS/CHANNEL SPACE (Except for U.S.A. and Canada)	8
Connecting audio components	9
Connecting video components	10
Connecting the system control	11
Connecting the speakers	12
Preparing the remote control	13
Preparing for surround sound	14
Surround setup	14
DSP mode setup	16
<hr/>	
Normal playback	18
Listening to a source component	18
Adjusting the sound	19
Recording	22
Recording audio	22
Recording video	22
Listening to radio broadcasts	23
Tuning radio stations	23
Tuning radio stations by frequency (DIRECT tuning)	24
Presetting radio stations	25
Receiving preset stations	25
Receiving preset stations in order (P.CALL)	25
Ambience effects	26
Sound modes	26
Surround play	27
<hr/>	
Getting the most from your remote control	30
Registering setup codes for other components	30
Operating other components	32
Changing (confirming) the operation mode	33
Preparing for automatic operations (MACRO play)	34
Executing an automatic operation	36
Setup code correlation	37
FutureSet upgrade option (1070VR only)	38
<hr/>	
Set up code chart	40
In case of difficulty	46
 Specifications	48
Remote operation of other components	49

Preparations

Operations

Remote Control

Other

Preparations

Operations

Remote Control

Other

True home theater sound

This receiver incorporates a wide variety of surround modes to bring you maximum enjoyment from your video software. Select a surround mode according to your equipment or the software you are going to play and enjoy! → [26](#)

Dolby Pro Logic & Dolby 3 Stereo

This surround system reproduces theater-like surround sound from video software marked  **DOLBY SURROUND**.

The PRO LOGIC mode uses the built in directivity enhancer circuit to control the Left, Center, Right and Surround channel audio signals and reproduce a real sense of sound motion.

The 3 STEREO mode uses the directivity enhancer circuit to provide proper acoustic positioning and a real sense of sound motion even when only the front and center speakers are used.

New DSP surround modes

The DSP (Digital Signal Processor) used for this receiver incorporates a variety of high quality adjustable sound fields, like "ARENA", "JAZZ CLUB" and "STADIUM", to add the "presence" associated with an arena, jazz club or stadium to the original signal. It is compatible with almost any kind of program source.

Universal IR (InfraRed) remote control

In addition to the basic receiver operations, the remote control supplied with this receiver can also operate almost all of your remote controllable audio and video components. Just follow the simple setup procedure to register the components you have connected. → [20](#)

Dual IR emitters

This remote control has two IR emitters: one to send commands in a straight line over long distances, allowing you to control the receiver and your other components from farther away; and one for wide dispersion of commands in a closer proximity, for near-field operation even when the remote control is not pointed directly at the respective component. → [13](#)

MACRO play

The MACRO function lets you perform a series of operations automatically, like turning ON the power of the receiver and connected components, switching the input selectors, and starting playback. (Be sure to register your components before starting the macro set up procedure.) → [34](#) → [36](#)

FutureSet, automatic update feature (1070VR only)

This function lets you update the remote control so it can operate new components which do not appear in the setup code list at the end of the manual. Therefore, the remote control will always be compatible. → [38](#)

New TRAITR transistor adopted in the final stage

A new TRAITR transistor which features superior temperature tracking characteristics has been adopted in the final stage of the power amplifier block. This new TRAITR transistor combines a temperature compensation resistor with an emitter resistor and final transistor to provide ideal temperature compensation characteristics and minimize distortion caused by temperature variations.

How to use this manual

This manual is divided in to four sections, **Preparations, Operations, Remote Control, and Other.**

Preparations

Shows you how to connect your audio and video components to the receiver and prepare the surround processor. We've tried to make setting up your system as easy as possible. However, since this receiver works with all of your audio and video components, connecting the system can be fairly complex.

Operations

Shows you how to operate the various functions available from the receiver.

Remote Control

Shows you how to operate the various functions available from the remote control. We've designed this remote control to integrate your entire audio/video system and let you operate all of your entertainment components — your TV, VCR, LD player, CD player, etc. Remember that before you can use the remote control to operate these components, they must be registered with a proper setup code.

Other

Includes additional information such as; a list of setup codes for registering your other components, a troubleshooting guide, specifications, and a reference guide to the remote operations available for registered components.

Names and functions of parts

1070VR/1060VR (En/K)

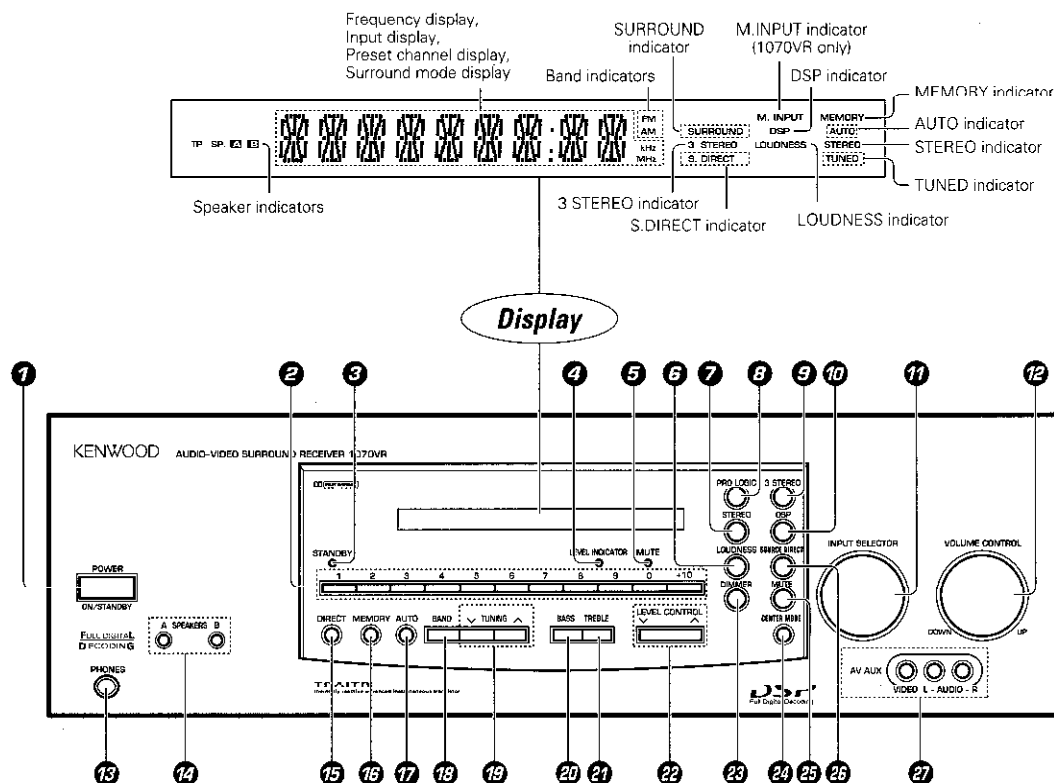

1 POWER key - 18
Use to switch the power ON/STANDBY.

2 Numeric keys
3 STANDBY indicator

4 LEVEL indicator - 17
Lights when the level of the signal being input is too high.

5 MUTE indicator - 19

6 LOUDNESS key - 19
Use to activate the frequency weighting network.

7 STEREO key - 27
Use to cancel the surround mode.

8 PRO LOGIC key - 27
Use to turn on the DOLBY PRO LOGIC mode.

9 DOLBY 3 STEREO key - 27
Use to turn on the DOLBY 3 STEREO mode.

10 DSP key - 27
Use to turn on, or switch, the DSP mode.

11 INPUT SELECTOR knob - 18
Use to select the input sources.

12 VOLUME CONTROL knob - 18
13 PHONES jack - 20

14 SPEAKERS A/B keys - 18

15 DIRECT key - 24
Use to tune radio stations directly by numerical input.

16 MEMORY key - 25
Use to store radio stations in the preset memory.

17 AUTO key - 25
Use to select the auto tuning mode.

18 BAND key - 23
Use to select the broadcast band.

19 TUNING keys - 23
Use to tune in radio broadcasts.

20 BASS key - 19
Use when adjusting the bass tone.

21 TREBLE key - 19
Use when adjusting the treble tone.

22 LEVEL CONTROL keys - 19
Use to adjust the level of the selected tone.

23 DIMMER key
Use to adjust the brightness of the display.

24 CENTER MODE key - 14
Use to select the center mode.

25 MUTE key - 19
Use to mute the sound.

26 SOURCE DIRECT key - 20
27 AV AUX jacks - 10

About the STANDBY indicator

This unit has a **STANDBY** indicator. When the **STANDBY** indicator is lit, the unit consumes a small amount of power to preserve the memory. This is called STANDBY mode. This mode also lets you turn the power ON using the remote control.

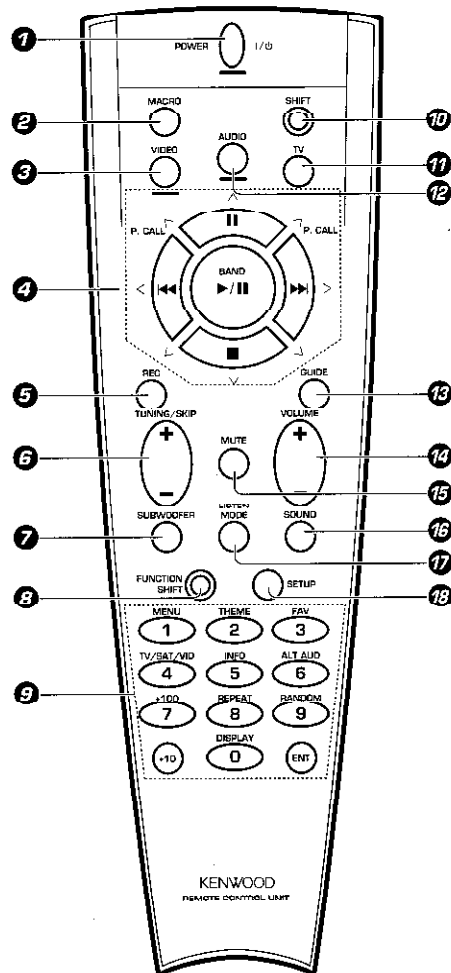

- 1 POWER key** → [32]
Use to turn the receiver on and off.
Use in combination with the Input selector (AUDIO, VIDEO, or TV) keys and SHIFT key to turn various components on and off.
- 2 MACRO key** → [34]
Use in combination with the AUDIO, VIDEO, or TV keys (AV AUX) and sets the remote to operate the component registered at the respective input.
- 3 VIDEO selector key** → [30]
Selects the video inputs (VIDEO 1, VIDEO 2, VIDEO 3, AV AUX) and sets the remote to operate the component registered at the respective input.
- 4 Multi control keys** → [49]
Use to operate the selected component.
- 5 REC key** → [49]
Use to operate the selected component.
- 6 TUNING/SKIP key** → [14] - [49]
Use during the setup procedure to specify various settings. Use to operate the tuner or selected component.
- 7 SUBWOOFER key** → [28]
Use in combination with the VOLUME +/- keys to adjust the volume of the subwoofer.

- 8 FUNCTION SHIFT key** → [49]
Use in combination with the numeric keys to execute alternate commands.
- 9 Numeric keys** → [49]
Provide functions identical to those of the original remote supplied with the component you are controlling.
To access the functions printed above the keys, Press within 3 seconds of pressing the FUNCTION SHIFT key. Function availability varies for each component.
- 10 SHIFT key** → [33]
Use in combination with the AUDIO and VIDEO keys to change the remote control mode without changing the input selector or in combination with the POWER key to turn on and off components programmed into the remote.
- 11 TV selector key** → [30]
Sets the remote to operate a TV or cable box (TV 1, TV 2, CABLE). This key does not change the input selector on the receiver.

- 12 AUDIO selector key** → [30]
Selects the audio inputs (CD, TAPE/MD, TUNER, DILONO) and sets the remote to operate the respective KENWOOD audio component.
If you connect audio components from KENWOOD and other makers to the TAPE/MD or CD jacks, you can set the remote to operate these components by registering the appropriate setup code at the respective input.
- 13 GUIDE key** → [42]
Use to activate the OSD menu functions of registered components.
- 14 VOLUME key** → [18]
Use to adjust the receiver volume.
- 15 MUTE key** → [19]
Use to temporarily mute the sound.
- 16 SOUND key** → [17]
Use to adjust the bass, treble, and input level.
- 17 LISTEN MODE key** → [28]
Use to select the desired surround mode.
- 18 SETUP key** → [14]
Use to adjust the surround setup.

Connecting the antennas

Make connections as shown below.

Do not connect the power cord to a wall outlet until all connections are completed.

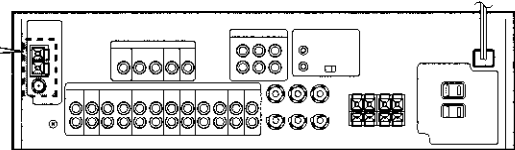
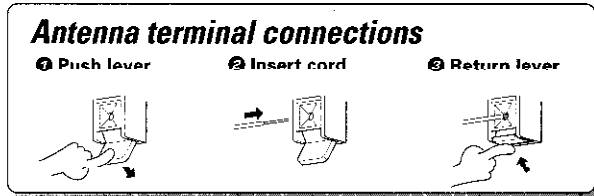

AM loop antenna

The supplied loop antenna is for use indoors. Place it as far as possible from the receiver, TV set, speaker cords and power cord, and adjust the direction for best reception.

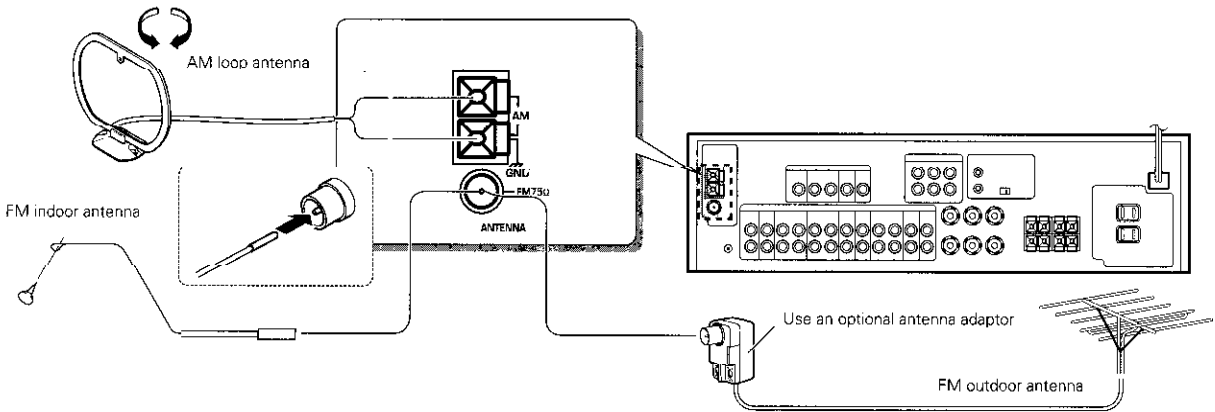

FM indoor antenna

The supplied indoor antenna is for temporary use only. For stable signal reception we recommend using an outdoor antenna. Disconnect the indoor antenna when you connect one outdoors.

FM outdoor antenna

Lead the 75Ω coaxial cable connected to the FM outdoor antenna into the room and connect it to the FM 75Ω terminal.

FM DE-EMPHASIS / CHANNEL SPACE (Except for U.S.A. and Canada)

The FM DE-EMPHASIS / CHANNEL SPACE switch on the rear panel is set to the correct setting that prevails in the area to which the unit is shipped. However, if the FM DE-EMPHASIS / CHANNEL SPACE setting is not matched to the area where the unit is to be used; for instance, when you move from area 1 to area 2 or vice versa, desired reception of AM / FM broadcasts is not expected. In this case, change the FM DE-EMPHASIS / CHANNEL SPACE setting in accordance with the area corresponding to the table. The FM DE-EMPHASIS is switched over at the same time.

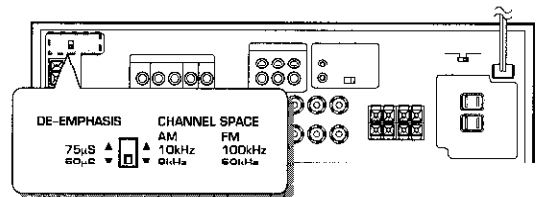

• When changing the setting of the FM DE-EMPHASIS / CHANNEL SPACE switch, first disconnect the power cord, then reset the channel space switch, connect the power cord again, and turn the power on.

	Area	CHANNEL SPACE freq.	FM DE-EMPHASIS
1	U.S.A., Canada and South American countries	FM: 100 kHz AM: 10 kHz	75 µs
2	Other countries	FM: 50 kHz AM: 9 kHz	50 µs

Connecting audio components

Make connections as shown below.

When connecting the related system components, be sure to also refer to the instruction manuals supplied with the components you are connecting.

Do not connect the power cord to a wall outlet until all connections are completed.

Microcomputer malfunction

If operation is not possible or an erroneous display appears, even though all connections have been made properly, reset the microcomputer referring to "In case of difficulty".

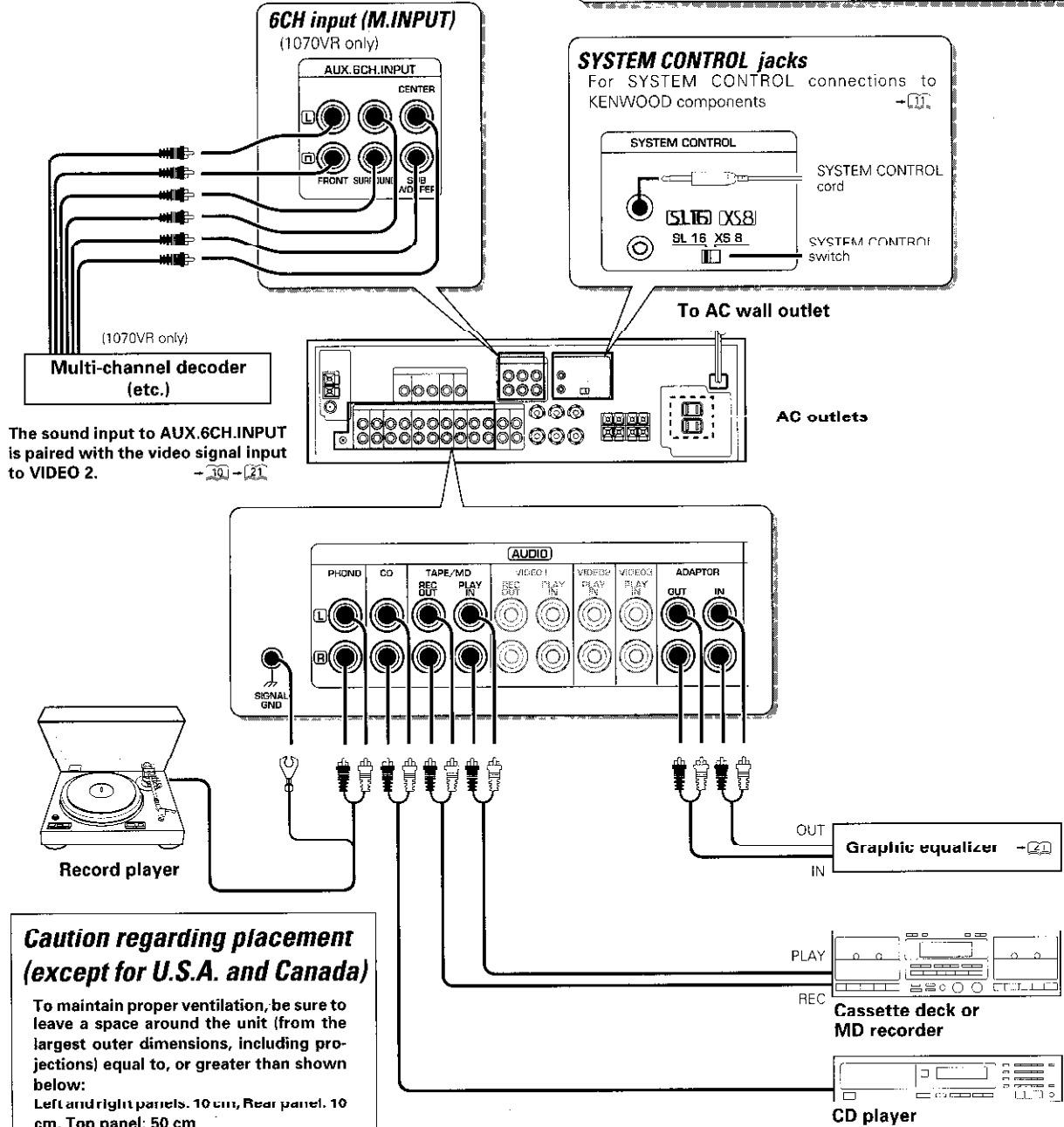

Caution regarding placement (except for U.S.A. and Canada)

To maintain proper ventilation, be sure to leave a space around the unit (from the largest outer dimensions, including projections) equal to, or greater than shown below:

Left and right panels: 10 cm, Rear panel: 10 cm, Top panel: 50 cm



1. Connect all cords firmly. Loose connections may prevent proper sound transmission or produce noise.
2. Be sure to remove the power cord from the AC outlet before plugging or unplugging any connection cords. Plugging / unplugging connection cords without disconnecting the power cord can cause malfunctions and may damage the unit.
3. Do not connect power cords from components whose power consumption is larger than what is indicated on the AC outlet at the rear of this unit.

Connecting video components

Make connections as shown below.

When connecting the related system components, be sure to also refer to the instruction manuals supplied with the components you are connecting.

Do not connect the power cord to a wall outlet until all connections are completed.

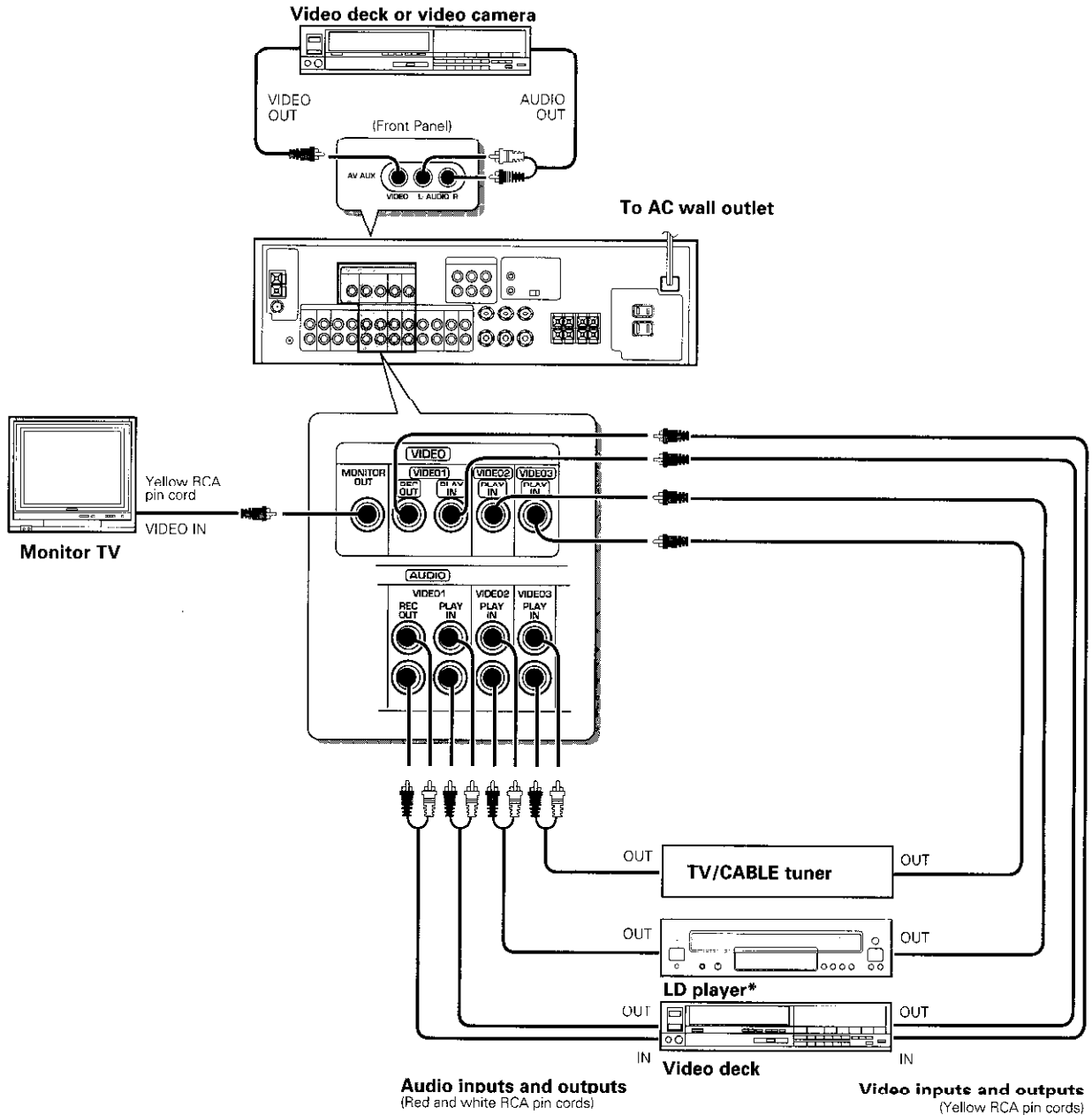

Audio inputs and outputs
(Red and white RCA pin cords)

Video inputs and outputs
(Yellow RCA pin cords)

* The video signal input to the VIDEO 2 jacks can be paired with audio signals input to the AUX.6CH.INPUT.

Connecting the system control

Connecting system control cords after connecting a KENWOOD audio component system lets you take advantage of convenient system control operations.

There are two KENWOOD system control modes. Make connections according to the groups of terminal symbols shown below.

[XS8] Mode : lets you combine [XS], [XS8], and [XR] terminals

[SL16] Mode : for [SL16] terminals only

This unit is compatible with both [XS8] and [SL16] modes. It comes from the factory set to the [SL16] mode. To switch to the [XS8] mode, follow the instructions in "SWITCHING FROM [SL16] TO [XS8]" below.

EXAMPLE: [XS8] mode connections

The underlined portion represents the setting of the system control mode.

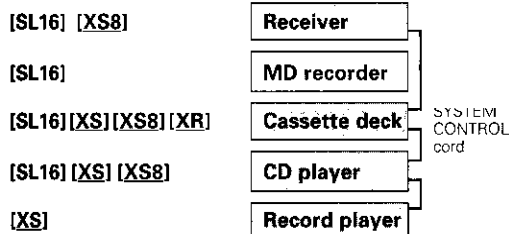

EXAMPLE: [SL16] mode connections

The underlined portion represents the setting of the system control mode.

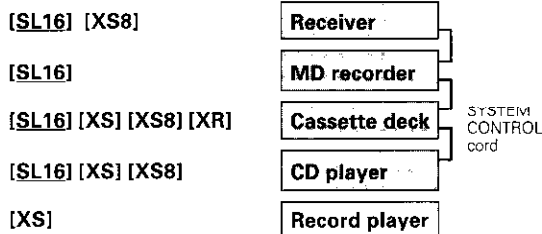

- In order to take advantage of the system control operations, the components must be connected to the correct jacks. To use a CD player it must be connected to the CD jacks. To use a cassette deck (or MD recorder) it must be connected to the TAPE/MD jacks. When using more than one CD player (etc.) only the one connected to the specified jacks may be connected for system control.
- Some CD players and cassette decks are not compatible with the [SL16] system control mode. Be sure to use the [XS8] system control mode when making system connections with equipment that is not [SL16] compatible.
- Some MD players are not system control compatible. You cannot make system control connections to this kind of equipment.

1. [SL16] equipment cannot be combined with [XR], [XS], and [XS8] equipment for system operations. If your equipment consists of this kind of combination, please do not connect any system control cords. Even without system control cords, normal operations can be carried out without effecting performance.
2. Do not connect system control cords to any components other than those specified by KENWOOD. It may cause a malfunction and damage your equipment.
3. Be sure the system control plugs are inserted all the way in to the system control terminals.



SYSTEM CONTROL OPERATIONS

Remote Control

Lets you operate this unit with the system remote supplied with the receiver.

Automatic Operation (except [XR] equipment)

When you start playback from a source component, the input selector on this unit switches to that component automatically.

Synchronized Recording (except [XR] equipment)

Lets you synchronize recording with the start of playback when recording from CD, MD or analog discs.

SWITCHING FROM [SL16] TO [XS8]

You can easily change the system control mode by adjusting the position of the SYSTEM CONTROL switch on the rear panel. Do this operation after completing all connections.

For [SL16] SL 16 XS 8 For [XS8]



- This operation will not effect items stored in the memory.
- After switching the system control mode, turn the power off and then on once to confirm the new setting.

Registering setup codes for KENWOOD audio components

- Once you finish making the system connections, be sure to register the appropriate setup code for each component. - [30]
- If you own remote controllable KENWOOD audio components that are not compatible with system control (or cannot be combined with your other system control components), registering the setup code enables you to control those components using the remote control supplied with this unit (without connecting system control cords). To register setup codes for your remote controllable KENWOOD audio components, see "Registering setup codes for other components". - [30]

Connecting the system control

Connecting system control cords after connecting a KENWOOD audio component system lets you take advantage of convenient system control operations.

There are two KENWOOD system control modes. Make connections according to the groups of terminal symbols shown below.

[XS8] Mode : lets you combine [XS], [XS8], and [XR] terminals

[SL16] Mode : for [SL16] terminals only

This unit is compatible with both [XS8] and [SL16] modes. It comes from the factory set to the [SL16] mode. To switch to the [XS8] mode, follow the instructions in "SWITCHING FROM [SL16] TO [XS8]" below.

EXAMPLE: [XS8] mode connections

The underlined portion represents the setting of the system control mode.

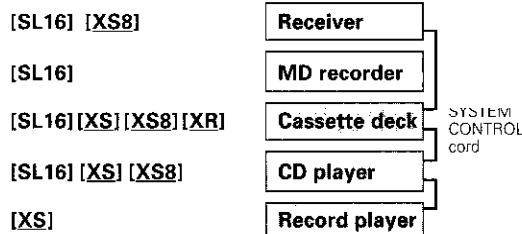

EXAMPLE: [SL16] mode connections

The underlined portion represents the setting of the system control mode.

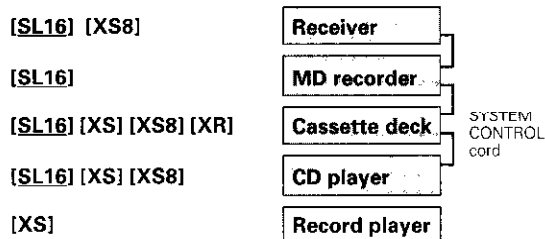

- In order to take advantage of the system control operations, the components must be connected to the correct jacks. To use a CD player it must be connected to the CD jacks. To use a cassette deck (or MD recorder) it must be connected to the TAPE/MD jacks. When using more than one CD player (etc.) only the one connected to the specified jacks may be connected for system control.
- Some CD players and cassette decks are not compatible with the [SL16] system control mode. Be sure to use the [XS8] system control mode when making system connections with equipment that is not [SL16] compatible.
- Some MD players are not system control compatible. You cannot make system control connections to this kind of equipment.



1. [SL16] equipment cannot be combined with [XR], [XS], and [XS8] equipment for system operations. If your equipment consists of this kind of combination, please do not connect any system control cords. Even without system control cords, normal operations can be carried out without effecting performance.
2. Do not connect system control cords to any components other than those specified by KENWOOD. It may cause a malfunction and damage your equipment.
3. Be sure the system control plugs are inserted all the way in to the system control terminals.

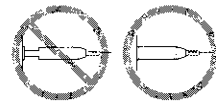

SYSTEM CONTROL OPERATIONS

Remote Control

Lets you operate this unit with the system remote supplied with the receiver.

Automatic Operation (except [XR] equipment)

When you start playback from a source component, the input selector on this unit switches to that component automatically.

Synchronized Recording (except [XR] equipment)

Lets you synchronize recording with the start of playback when recording from CD, MD or analog discs.

SWITCHING FROM [SL16] TO [XS8]

You can easily change the system control mode by adjusting the position of the SYSTEM CONTROL switch on the rear panel. Do this operation after completing all connections.

For [SL16] SL 16 XS 8 For [XS8]



- This operation will not effect items stored in the memory.
- After switching the system control mode, turn the power off and then on once to confirm the new setting.

Registering setup codes for KENWOOD audio components

- Once you finish making the system connections, be sure to register the appropriate setup code for each component.
- If you own remote controllable KENWOOD audio components that are not compatible with system control (or cannot be combined with your other system control components), registering the setup code enables you to control those components using the remote control supplied with this unit (without connecting system control cords). To register setup codes for your remote controllable KENWOOD audio components, see "Registering setup codes for other components".

Connecting the speakers

- 1 Strip coating.
- 2 Loosen.
- 3 Insert.
- 4 Secure.

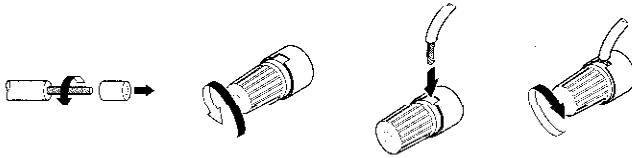

- Never short circuit the + and - speaker cords.
- If the left and right speakers are connected inversely or the speaker cords are connected with reversed polarity, the sound will be unnatural with ambiguous acoustic imaging. Be sure to connect the speakers correctly.
- To emphasize deep base sounds, connect a subwoofer as desired.

Connection of banana plugs

- 1 Secure.



- 2 Insert.

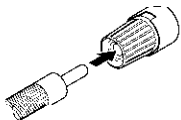

- Sound will not be heard if the speaker terminal is not fully secured

Front Speakers A

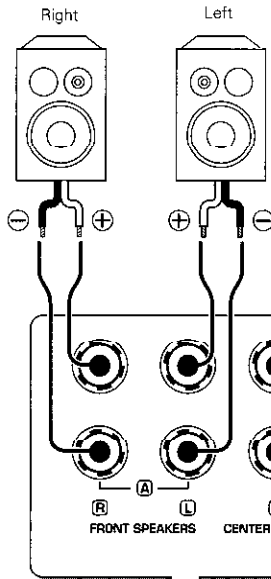

Front speaker impedance:

- 1070VR: (A OR B: 8-16 Ω, A AND B: 8-16 Ω)
- 1060VR: (A OR B: 8-16 Ω, A AND B: 8-16 Ω)

Center Speaker

- Center speaker impedance:**
- 1070VR: (8-16 Ω)
- 1060VR: (8-16 Ω)

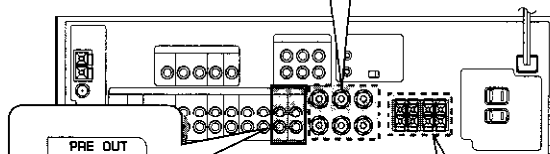

Use the **FRONT SPEAKERS B** terminals if you want to connect a second front speaker system.

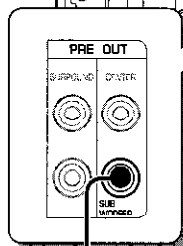

Powered subwoofer

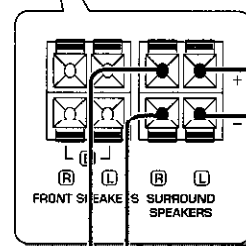

Surround Speakers

- Surround speaker impedance:**
- 1070VR: (8-10 Ω)
- 1060VR: (4-16 Ω)

(Be sure to connect both surround speakers)

PRE OUT connections

This receiver has additional preout jacks. These can be used for various purposes, but will need to be connected to an external power amplifier as shown in the example below. Connecting a speaker cord directly to a PRE OUT jack will not produce any sound from the speaker.

Be sure to set one of the SPEAKERS keys (either A or B) to the ON position when using the PRE OUT jacks.

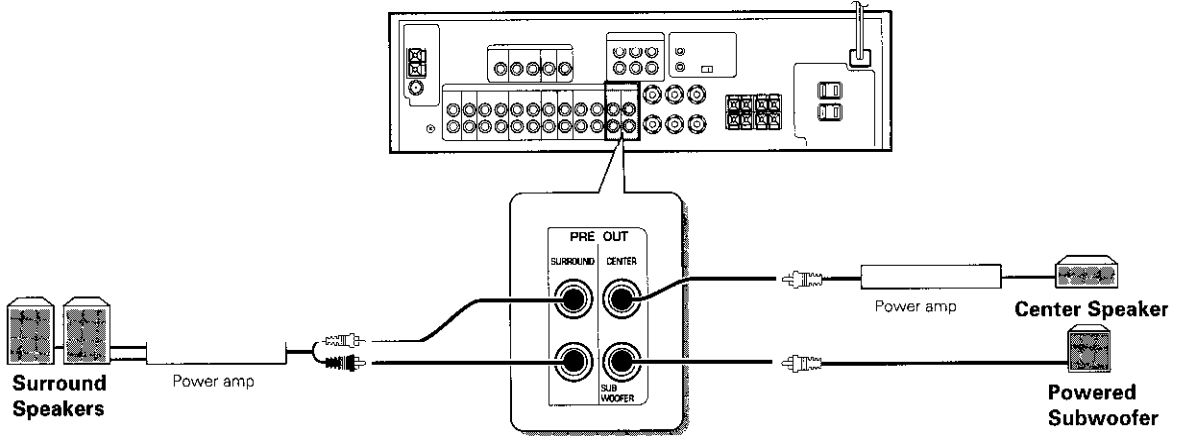

Preparing the remote control

Loading the batteries

➊ Remove the cover.

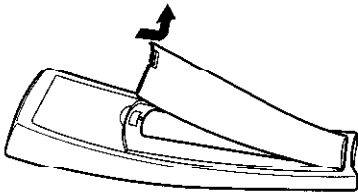

➋ Insert the batteries.

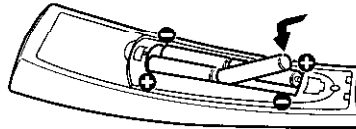

➌ Close the cover.

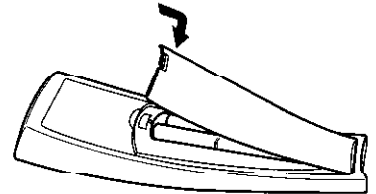

• Insert four AAA-size (LR03) batteries as indicated by the polarity markings.



1. The supplied batteries may have shorter lives than ordinary batteries due to use during operation checks.
2. Replace all four batteries with new ones when you notice a shortening of the distance from which the remote control will operate or if the remote control blinks 5 times when you push a key. The remote control is designed to retain set up codes in memory while you change batteries. Failure to change batteries after receiving the 5 blink battery warning signal may cause all the memory to be lost (1060VR only).
3. Placing the remote sensor in direct sunlight, or in direct light from a high frequency fluorescent lamp may cause a malfunction. In such a case, change the location of the system installation to prevent malfunction.

Operating distance

This remote control has two IR emitters: one to send commands in a straight line over long distances, allowing you to control the receiver and your other components from farther away; and one for wide dispersion of commands in a closer proximity, for near-field operation even when the remote control is not pointed directly at the respective component.

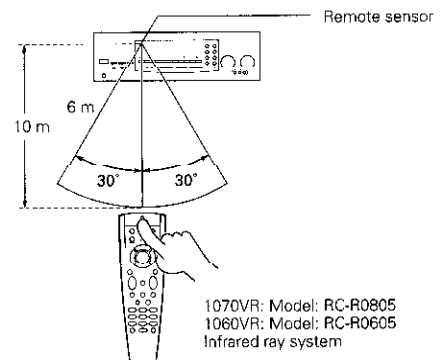

1070VR: Model: RC-R0805
1060VR: Model: RC-R0605
Infrared ray system

Preparing for surround sound

1070VR/1060VR (En/K)

To enhance the surround modes, various parameters can be set up to accommodate the speaker system used and the environment of the listening room. The following procedure let you set the parameters of the surround modes (DOLBY PRO LOGIC, DOLBY 3 STEREO and DSP). Once the settings have been done, it is held in memory so readjustment is not necessary even after the mode has been changed.

Recommended speaker installation

It is recommended that the surround speakers are installed straight to the left and right of the listening position or slightly behind, at a height of about 1 meter higher than the listener's ears. Each surround speaker should be installed so that the longer sides are horizontal.

Surround setup

1 Select the Dolby Pro Logic surround mode.

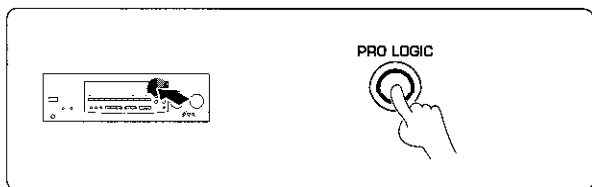

- The following adjustments (center mode, test tone, etc.) are common for all surround modes, including DSP. You do not need to make separate adjustments for each sound mode.

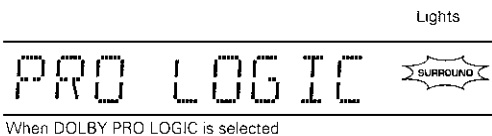

2 Select the CENTER MODE.

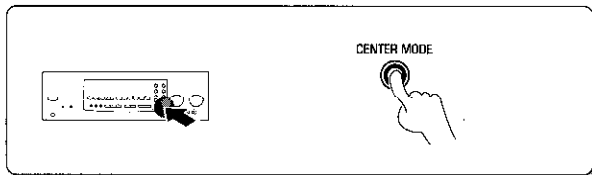

When you select PRO LOGIC, each press of the **CENTER MODE** key switches the center mode as follows:

- ① **"NORMAL"** :When using a standard (small) center speaker.
- ② **"WIDE BAND"** :When using a full range (large) center speaker.
- ③ **"PHANTOM"** :When not using a center speaker.

3 Turn on the SUBWOOFER.

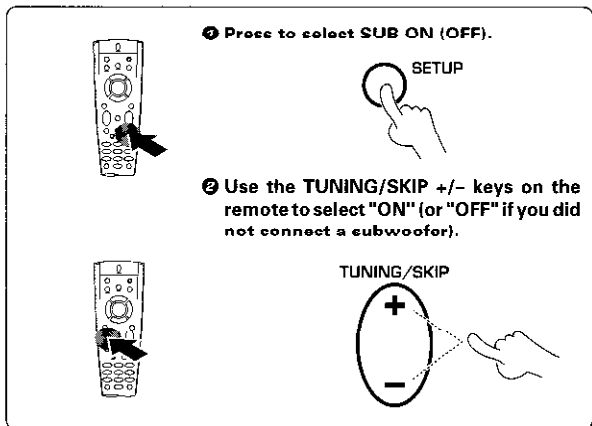

- If you did not connect a subwoofer, select **"SUB OFF"**.



DSP mode setup

1 Select a DSP mode.

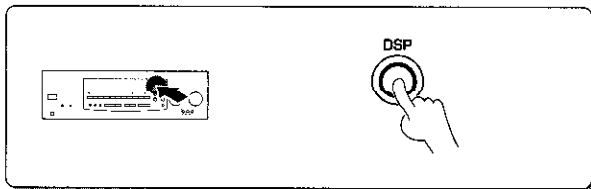

- The following adjustments (effect level, wall type, and room size) are common for all DSP modes. If necessary these modes can be adjusted again according to your preference after listening to the surround effect they produce.
- The subwoofer, center mode and test tone adjustments made in the PRO LOGIC mode are automatically applied to the DSP modes. — 14

2 Adjust the EFFECT level.

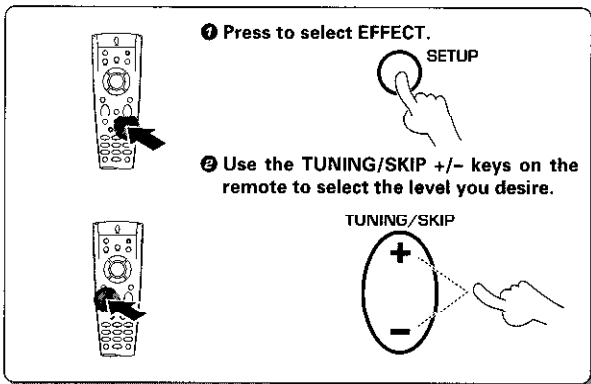

Lights
ARENA DSP

When the "ARENA" DSP mode is selected

EFFECT 3 DSP

Display when the EFFECT level setting is selected

- The EFFECT level is adjustable in 5 steps, 1 ↔ 5 (larger number represent a stronger effect).

3 Adjust the WALL type.

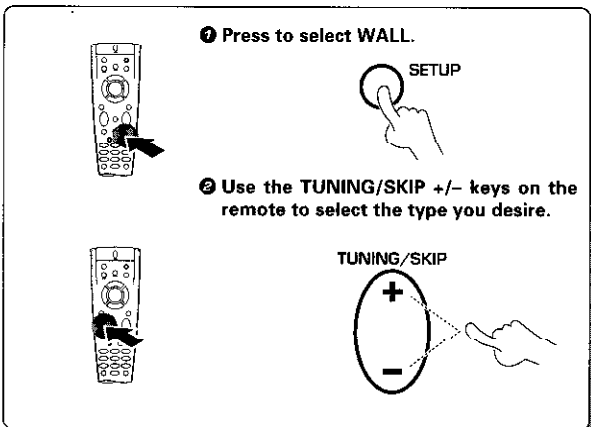

WALL HARD DSP

Display when the WALL type setting is selected

- The WALL type is adjustable in 3 steps, "HARD" (hard), "MED" (medium) and "SOFT" (soft).

4 Adjust the ROOM size.

1 Press to select **ROOM**.

2 Use the **TUNING/SKIP +/-** keys on the remote to select the size you desire.

3 Press **SETUP** again to quit.

4 Press **VIDEO** once to return the remote to its original operating mode.

ROOM MED

Display when the ROOM size setting is selected

The ROOM size is adjustable in 3 steps, "**SM**" (small), "**MED**" (medium) and "**LRG**" (large).

The input selector does not change the first time you press the **VIDEO** key.

Input level adjustment

The LEVEL INDICATOR lights during playback if the signal from an analog source is too large. If this occurs, use this function to attenuate the level for that source.

1 Press the **VIDEO**, **AUDIO**, or **TV** key repeatedly to select the desired component.

2 Press to select **IN LVL**.

3 Select the smallest level required to extinguish the LEVEL INDICATOR.

4 Press the **SOUND** key again to quit.

5 Press **VIDEO** once to return the remote to its original operating mode.

Input level adjustment is not possible when using the **AUX.6CH INPUT** or **ADAPTOR** jacks.

The display changes as shown below:

- ① "BASS"
- ② "TREBLE"
- ③ "IN LVL"

IN LVL -3 dB

Display when IN LVL is selected

The input level is adjustable in 3 steps, 0 dB ↔ -3 dB ↔ -6 dB (normally set to 0 dB).

The bass and treble settings can also be adjusted using this procedure.

The input selector does not change the first time you press the **VIDEO** key.

Preparations • Turn on the power to the related components.

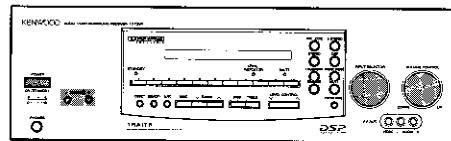
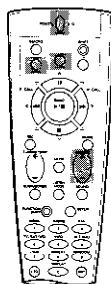

Keys or controls used in this operation.

Listening to a source component

1 Turn on the receiver.

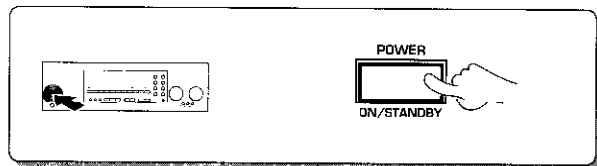

2 Select a speaker system.

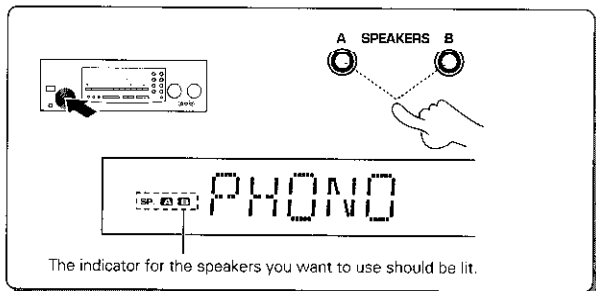

3 Select the source you desire.

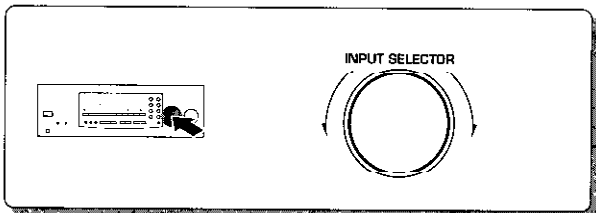

4 Start playback from the selected source.

5 Adjust the volume.

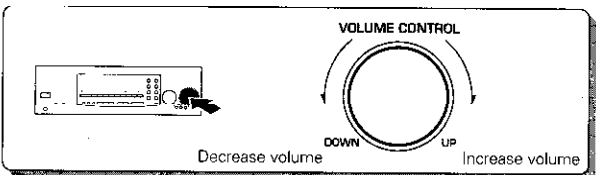

- A ON** : Sound from the speakers connected to the SPEAKERS A terminals on the rear panel.
- B ON** : Sound from the speakers connected to the SPEAKERS B terminals on the rear panel.
- A+B ON** : Sound from both the speakers connected to the SPEAKERS A and B terminals on the rear panel.
- A+B OFF** : No sound from the speakers. Use this setting when listening with headphones for stereo sound in all playback modes.

• When both SPEAKERS A and B are ON, activating a surround mode turns SPEAKERS B OFF automatically.

The input sources change as shown below:

- ① TUNER (Frequency display)
- ② "PHONO" ("PHONO"*)
- ③ "VIDEO1" ("SAT"*)
- ④ "VIDEO2" ("LD"*)
- ⑤ "VIDEO3" ("VCR"*)
- ⑥ "AV AUX"
- ⑦ "CD" ("CD"*)
- ⑧ "TAPE/MD" ("TAPE"*)

* Once setup codes are registered. In the remote control, the input name display changes according to the name of the registered component. Example: if you register a VCR at the VIDEO 1 jacks, "VCR1" appears instead of "VIDEO 1". - [30]

• When using the remote control after initial setup, any inputs that have not been registered with a setup code are deleted from the cyclic list (except for the "AV AUX" VIDEO input). - [32]

• The INPUT SELECTOR on the front panel of the receiver always cycles through all inputs.

Volume display

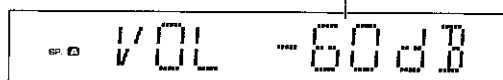

To adjust the balance

Use the test tone feature.

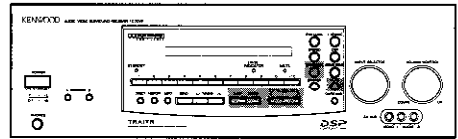
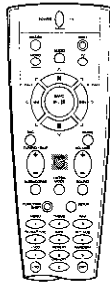

Keys or controls used in this operation.

Adjusting the sound

Adjusting the tone

1 Press the **BASS** or **TREBLE** key to select the tone mode to be adjusted.

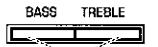
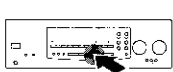

2 Adjust the tone.

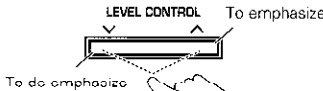
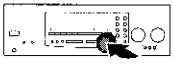

3 Press again to quit.

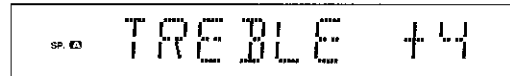
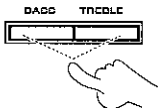

Display when "TREBLE" is selected.

The displayed value changes.

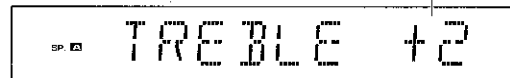

- The bass and treble levels are adjustable from -10 to +10 in 2 step increments.
- These adjustments can also be made by using the **SOUND** and **TUNING/SKIP** keys on the remote control.

Emphasizing deep bass (LOUDNESS)

LOUDNESS lets you emphasize the sound of frequencies that are difficult to hear. The frequency emphasis varies according to the volume at which you are listening.



LOUDNESS



Press again to return to previous sound.

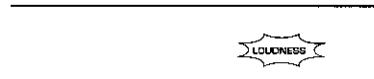

To cancel
Press again.



Goes out

Muting the sound

MUTE lets you mute the sound of the speakers.

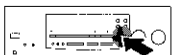



MUTE

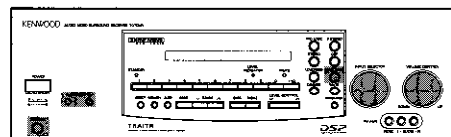
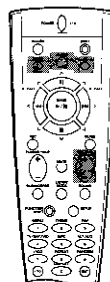

- The **MUTE** indicator on the front panel blinks when muting is turned on.

To cancel
Press again.



 Keys or controls used in this operation.

SOURCE DIRECT playback

Use this function to pass the source material direct to the amplifier, bypassing any audio processing.

1 Select a playback source.

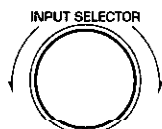
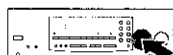

2 Press the SOURCE DIRECT key.

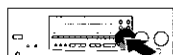

3 Start playback.

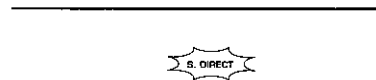

- Tone controls do not work during SOURCE DIRECT playback.
- Pressing the **STEREO** key or any of the keys related to surround playback will cancel SOURCE DIRECT playback.

To cancel Press again.

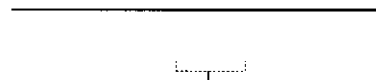

Goes out

- If SOURCE DIRECT playback was activated when using a surround mode, cancelling it reactivates the previous surround mode.

Listening with headphones

1 Turn OFF both speaker switches.

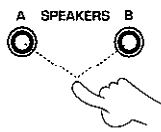
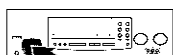

2 Connect headphones.

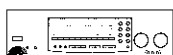

3 Adjust the volume.

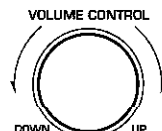
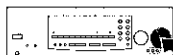

Decrease volume

Increase volume

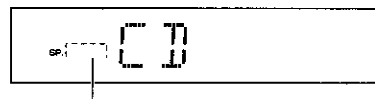

Make sure the SPEAKERS indicators are turned off.

- Turning off both **SPEAKERS A** and **B** when using a surround mode will cancel the respective mode and activate stereo playback.

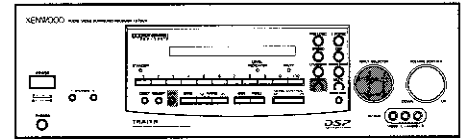
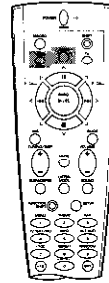

Keys or controls used in this operation.

6CH.INPUT playback (1070VR only)

This function allows you to pair the video signal input to the VIDEO 2 VIDEO jack with audio signals input to the 6CH.INPUT jacks.

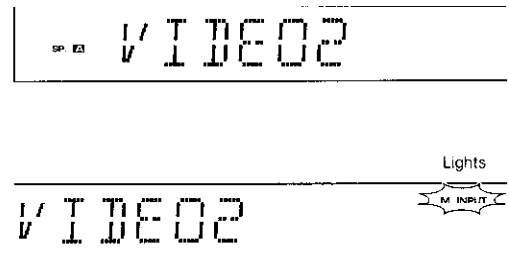
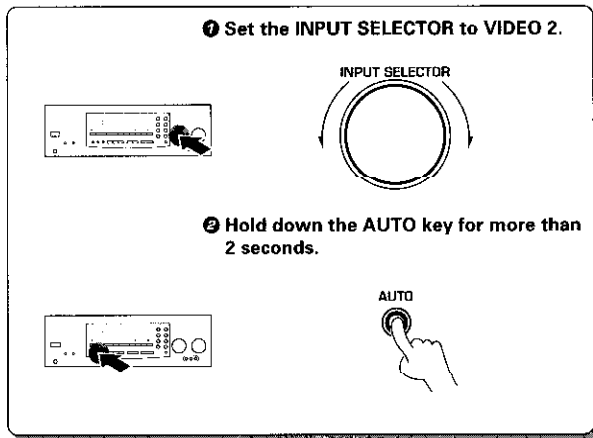

- When the receiver is set to this mode, it functions as a multi-channel amplifier (the surround effects (etc.) cannot be activated).
- The sound of the front channel is output from the SPEAKERS A only.
- The receiver switches to the multi-channel amplification mode automatically whenever VIDEO 2 is selected.
- To undo this setting and listen to the audio signals input to the VIDEO 2 AUDIO jacks, repeat this procedure so that "M.INPUT" goes out.

Listening with a graphic equalizer

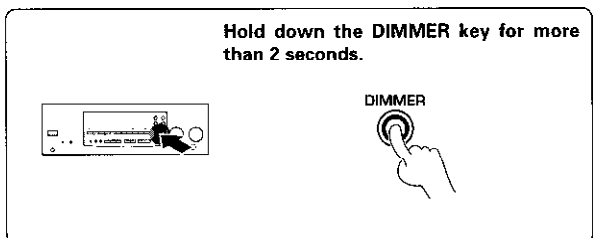

Appears for a few seconds after the adaptor input is turned on.

- When the receiver is set to this mode, the audio signals are looped through the graphic equalizer connected to the ADAPTOR OUT and IN jacks on the rear panel.
- When the adaptor is on, the overall volume is slightly decreased.
- To undo this setting, repeat this procedure to display "ADPT OFF".

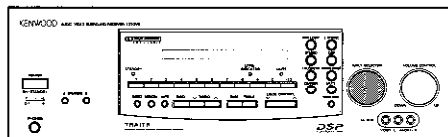
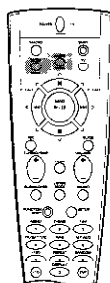

Keys or controls used in this operation.

Recording audio

Recording a music source

- 1 Select the source you want to record.

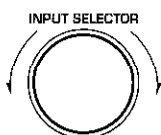

Select a source other than TAPE

- 2 Set the cassette deck to record.
- 3 Start playback, then start recording.

Recording video

- 1 Select the source you want to record.

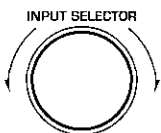
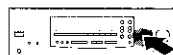

Select a source other than VIDEO 1

- 2 Set the video deck to record.
- 3 Start playback, then start recording.

- The AV AUX jacks on the front panel provide a convenient way to connect a video camera (playback only).

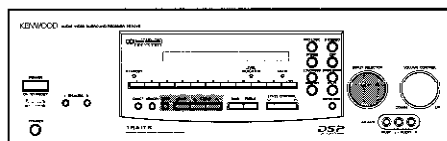
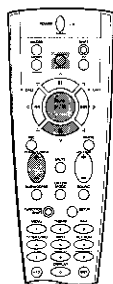

Keys or controls used in this operation.

Tuning radio stations

1 Set the input to tuner.

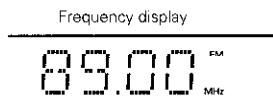
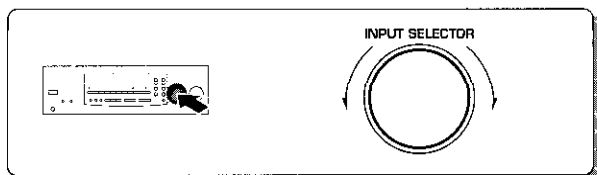

2 Select a broadcast band.

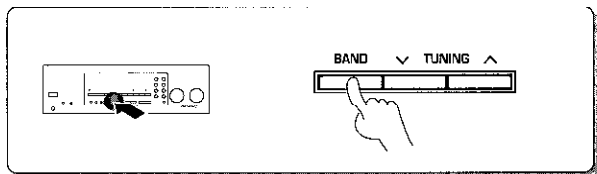

Each press switches the band as follows:

- ① FM
- ② AM

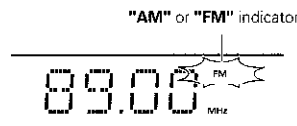

3 Select a tuning method.

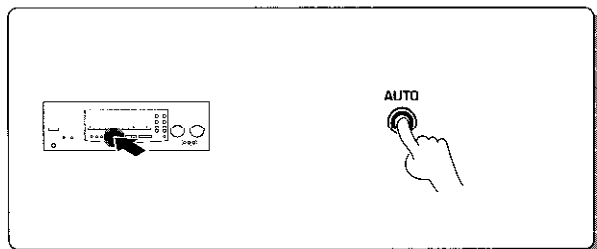

Each press switches the tuning method as follows:

- ① AUTO lit (auto tuning)
- ② AUTO not lit (manual tuning)



- Normally, set to "AUTO" (auto tuning).
- If the radio waves are weak and there is a lot of interference, switch to manual tuning. (With manual tuning, stereo broadcasts will be received in monaural.)

4 Select a station.

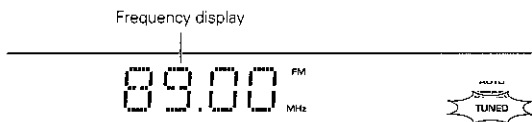
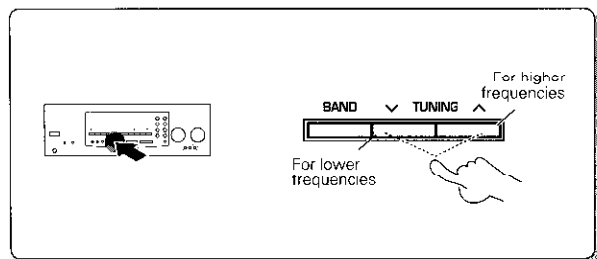

"TUNED" is displayed when a station is received

- Auto tuning : The next station is tuned automatically.
- Manual tuning : Press repeatedly or hold to tune the station.

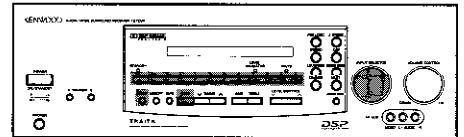
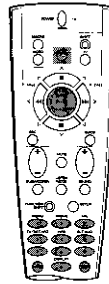

 Keys or controls used in this operation.

Tuning radio stations by frequency (DIRECT tuning)

1 Set the input to tuner.

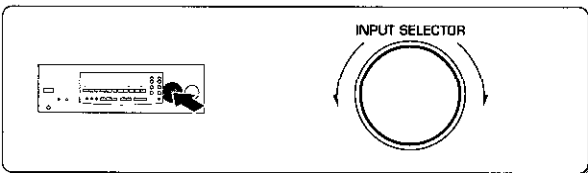

Frequency display



2 Select a broadcast band.

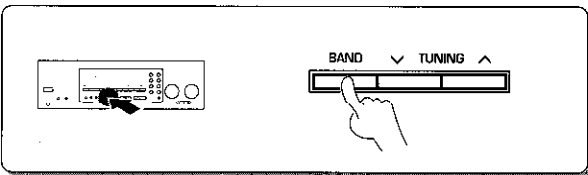

Each press switches the band as follows:

- ① FM
- ② AM

"AM" or "FM" is displayed



3 Enter the frequency.

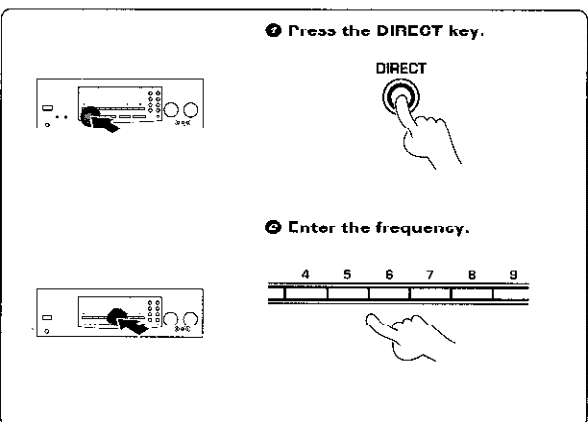

Press the numeric keys in the following order:

* AM 10 kHz/FM 100kHz tuning space (U.S.A., Canada, etc.)

- AM 810 kHz, press **8**, **1**
- AM 1260 kHz, press **1**, **2**, **6**
- FM 90 MHz, press **9**, **0**, **0**
- FM 102.5 MHz, press **1**, **0**, **2**, **5**

* AM 9 kHz/FM 50 kHz tuning space (other countries)

- AM 810 kHz, press **8**, **1**, **0**
- AM 1260 kHz, press **1**, **2**, **6**, **0**
- FM 90 MHz, press **9**, **0**, **0**, **0**
- FM 102.5 MHz, press **1**, **0**, **2**, **5**, **0**

* FM DE-EMPHASIS/CHANNEL SPACE switch.

Frequency display

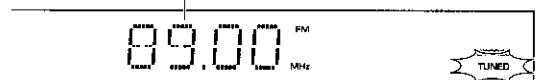

"TUNED" is displayed when a station is received

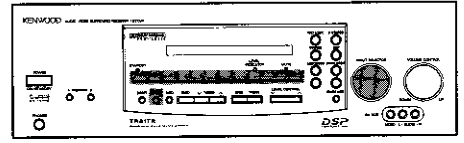
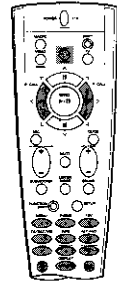

• If you make a mistake entering the frequency, the frequency display will blink for a few seconds. In this case, start again from step 3.

Preparation • Select tuner.



Keys or controls used in this operation.

Presetting radio stations

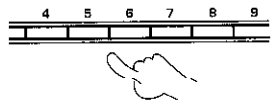
- 1 Tune to the station you want to store.
- 2 Press the MEMORY key while receiving the station.
 

- 3 Enter a preset number (1~40).
 

Proceed to step 3 within 5 seconds. (If more than 5 seconds elapse, press MEMORY again.)

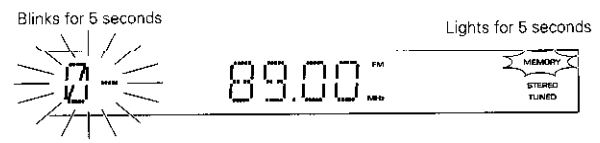
- When storing radio stations manually, it may take a few minutes before the "MEMORY" indicator appears in the display after pressing the MEMORY key depending on receiving conditions.





Press the numeric keys in the following order:

- For "15", press **+10**, **5**
- For "20", press **+10**, **+10**, **0**

- Repeat steps 1, 2 and 3 to store as many stations as necessary.
- If you store a station at a previously used preset, the old station will be replaced by the new one.

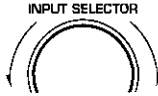
Receiving preset stations

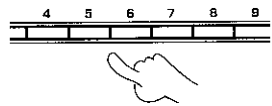
- 1 Select tuner.
 

- 2 Enter the number of the preset you want to receive (up to "40").
 

Press the numeric keys in the following order:

- For "15", press **+10**, **5**
- For "20", press **+10**, **+10**, **0**

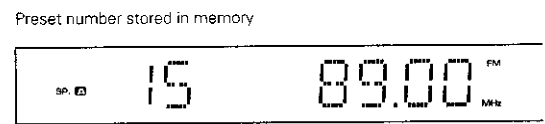
- If you make a mistake entering a two digit number, press the +10 key several times to return to the original display and start again.



Receiving preset stations in order (P.CALL)

When using the remote control, press AUDIO to select the tuner control mode.



P. CALL Preset numbers ↑

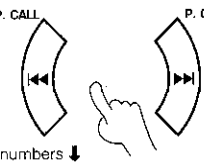

P. CALL

Preset numbers ↓

- Each time you press the key, another preset station is received in order.

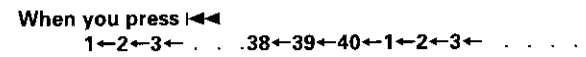
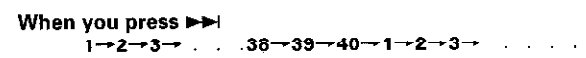

Holding down the button, lets you skip through the presets, receiving each for 0.5 seconds apiece.

This receiver incorporates 3 different sound modes to let you enjoy surround sound with a wide variety of program sources. The Dolby Pro Logic surround sound let you enjoy theater-like surround effects when you play Dolby Pro Logic program sources (like Laserdiscs). Dolby 3 Stereo creates a panoramic frontal sound field while keeping dialog on screen. The Digital Signal Processing (DSP) modes let you create a variety of different sonic environments from almost any type of program source.

To obtain the best possible surround sound, be sure to complete "Preparing for surround sound" before using the surround modes.

-14

Sound modes

Dolby Pro Logic

Dolby Pro Logic is a specially encoded 2 channel surround format designed to provide theater-like surround sound from Dolby Pro Logic program sources (such as video and Laserdisc software marked **DOLBY SURROUND**). This receiver is equipped with a Dolby Pro Logic surround decoder to let you enjoy the wide variety of currently available Dolby Pro Logic home video software.

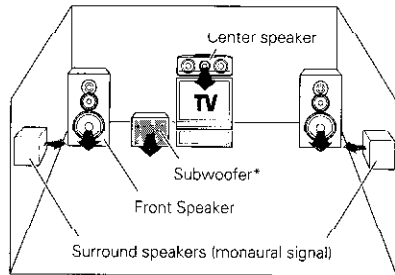

* Optional in this mode.

Dolby 3 Stereo

Dolby 3 Stereo creates a panoramic frontal sound field while maintaining the dialog in an on-screen position. This mode is designed for use with Dolby program sources, but can also improve sound field unity for non-Dolby program sources. Dialog positioning and sound image definition, however, may not be as accurate when used with non-Dolby program sources.

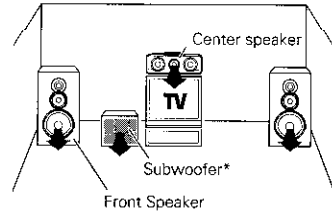

* Optional in this mode.

DSP mode

The DSP mode lets you add the atmosphere of an arena, jazz club, or stadium to almost any type of program source.*

These modes are particularly effective when used with stereo program sources, like CD, television, and FM radio. You might enjoy trying the STADIUM or ARENA mode the next time you watch a concert or sporting event!

The WALL parameter lets you adjust the "brightness" of the sonic environment according to your preference. -16

The ROOM SIZE parameter lets you adjust the size of the sonic environment according to your preference. -17

The EFFECT level lets you adjust the "presence" of the sonic environment according to your preference. -16

*The DSP mode will produce a stereo-like surround effect from monaural sources, but there will be some reduction in the presence of the arena, jazz club, or stadium.

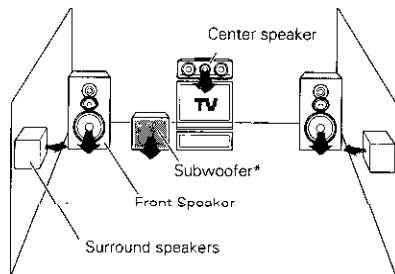

* Optional in this mode.

DOLBY PRO LOGIC and DOLBY 3 STEREO can be used when playing video or LD software bearing the  mark. DSP modes can be used with any source. Be sure to complete "Preparing for surround sound" before using any of these surround modes.

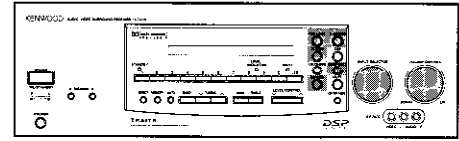
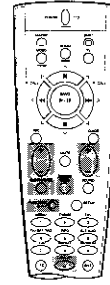

 : Keys or controls to be used in this operation

Preparations

- Turn ON related components.
- Complete "Preparing for surround sound".
- Set the **INPUT SELECTOR** to the component you wish to play back with surround sound.

Surround play

1 Select a surround mode.

The surround mode settings are stored separately for each input.

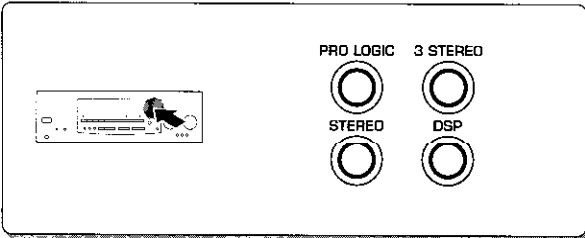

STEREO : Cancels surround playback.

PRO LOGIC : Selects the DOLBY PRO LOGIC mode.

3-STEREO : Selects the DOLBY 3 STEREO mode.

DSP : Selects the DSP mode. Each press changes the DSP mode as follows:

- "ARENA" : Simulates the presence of an indoor concert arena.
- "JAZZ CLUB" : Simulates the presence of a jazz club.
- "STADIUM" : Simulates the presence of an outdoor stadium.

2 Start playing the video software.

3 Adjust the volume.



Example when DOLBY PRO LOGIC is selected

Convenient functions

Display dimmer adjustent

The **DIMMER** key on the front panel lets you select the brightness of the receiver's display. You might find this useful if you darken your room to watch movies or listen to music.

When the remote control is set to operate a video component, the **FUNCTION SHIFT** and **DISPLAY** key combination can be used to change the display on the respective video component.

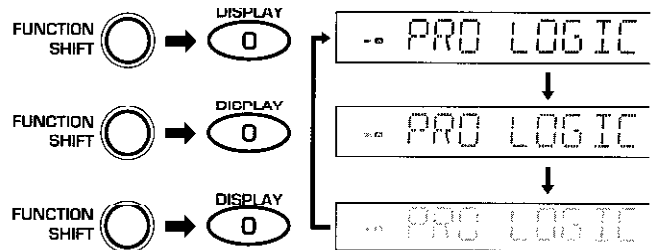

continued on next page

SOURCE DIRECT key

Lets you pass the source material direct to the amplifier, bypassing any audio processing. When SOURCE DIRECT is ON, surround sound is turned off and the tone controls are bypassed.

Press to switch.

**LISTEN MODE key**

The LISTEN MODE key on the remote control lets you switch the sound mode directly from the remote control.

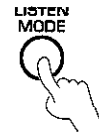

Press to switch.

- ① STEREO
- ② PRO LOGIC
- ③ 3 STEREO
- ④ ARENA
- ⑤ JAZZ CLUB
- ⑥ STADIUM

SUBWOOFER adjustment

The SUBWOOFER key on the remote control lets you adjust the output level of the subwoofer while listening to a favorite source. First press the SUBWOOFER key to select the subwoofer operation mode, then use the VOLUME key to adjust the output level.

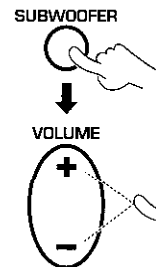

Display when SUBWOOFER is pressed.

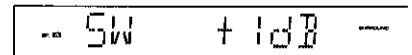

The displayed value changes.

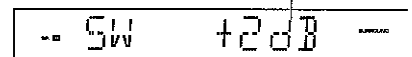

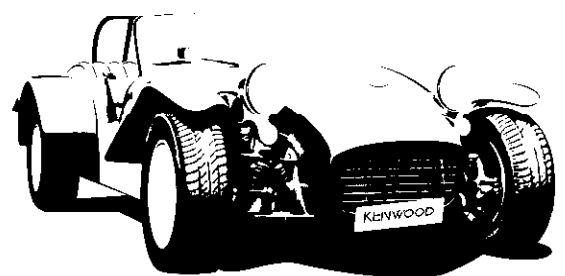

Getting the most from your remote control

1070VR/1060VR (En/K)

The remote control supplied with this receiver is also capable of controlling components from a variety of manufacturers once you register the appropriate setup codes into the remote control unit.

Refer to "Remote operation of other components" for details about the operations available for each component. - 49

* When registering setup codes for KENWOOD audio components which are connected to this unit by system control cords, use the following codes to insure proper system control operation: Cassette: 7000, CD: 8099, MD: 9000. - 11

To control other KENWOOD components (VCRs, LD players, audio components not connected with system control cords, etc.) follow the procedure described below.

Low battery warning

Replace all four batteries with new ones when you notice a shortening of the distance from which the remote control will operate or if the remote control blinks 5 times when you push a key. The remote control is designed to retain set up codes in memory while you change batteries. Failure to change batteries after receiving the 5 blink battery warning signal may cause all the memory to be lost (1060VR only).

Registering setup codes for other components

1 Find the setup code of the component to be registered.

• Refer to the setup code lists to find the setup code for the component to be registered. - 40

Example: To register a CD made by KENWOOD, you would enter "8037"

• If you purchase a new component that is not covered by the setup code list, you can use the FutureSet upgrade feature (1070VR only). - 36

2 Hold down the ENT key until the backlight flashes twice and remains lit.



3 Select the component to be registered.

Press the VIDEO, AUDIO, or TV key repeatedly to select the desired component.

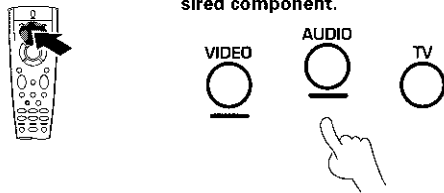

Input	Component	Maker	Code	Key
(CD)	CD player	KENWOOD	8028, 8037	AUDIO
VIDEO 1				
VIDEO 2				
VIDEO 3				
TAPE/MD				
CD				
PHONO				
—	TV 1			
—	TV 2			
—	CABLE			

• At this time all inputs become available regardless of any earlier registration.



Perform each of the following steps within 5 seconds.

VIDEO key

- ① VIDEO1 (SAT)
- ② VIDEO2 (LD)
- ③ VIDEO3 (VCR)

AUDIO key

- ① CD (CD)
- ② TAPE/MD (TAPE)
- ③ PHONO

TV key

- ① TV1
- ② TV2
- ③ CABLE

- Example: To register the component connected to the VIDEO 1 jacks, select "VIDEO 1 (SAT)".

— SAT

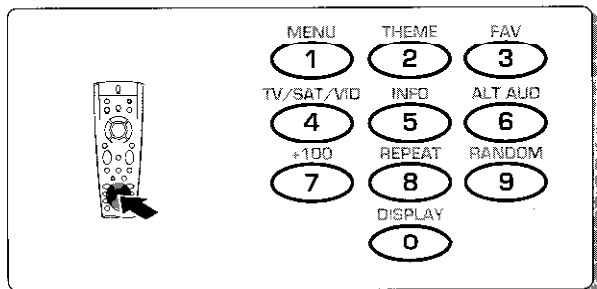
4 Enter the setup code.

- Example: Press 5258 to register a LD player made by KENWOOD.
- The backlight flashes once each time a number is entered.
- If an invalid setup code is entered the remote will output one long blink, disregard that code and return to the beginning of step 4.
- If you push an invalid key, the remote will exit the setup mode.

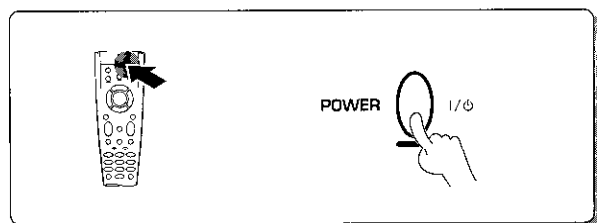
5 Press **POWER**, and check to see that the component you want to control turns on.

- **PLAY** or **TUNING/SKIP** (+/-) can also be used instead of **POWER**.
- If the component does not react, and there is more than one setup code, enter another setup code and try again.
- If the component is already on, pressing **POWER** will turn it off.

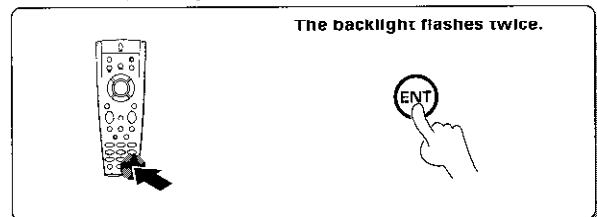
6 Press the **ENT** key to store the code you have just input.

- This code replaces any previous setup codes entered for the respective component.

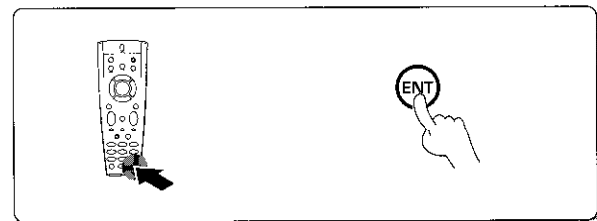
7 Repeat steps 3 to 6 to register additional components until all components have been registered.**8** Once setup codes have been entered for all components, hold down the **ENT** key until the backlight flashes twice.

- If you have components that are not remote controllable, like a record player (etc.), you will need to register a Non-IR code at the respective input. This keeps the respective input in the remote control's cyclic list so you can select it using the remote control. Please consult the owner's manual of the components you are connecting for information regarding remote controllability. The list of Non-IR codes is included at the beginning of the Set up code chart. -40

- This operation should take about 3 seconds.
- Once registered, the display on the receiver shows the component type instead of the default input name. Example: if you register a VCR at the VIDEO 1 jacks, "VCR" appears instead of "VIDEO 1(SAT)".
- After initial setup, any VIDEO (VIDEO 1, 2, 3) or TV (TV1, TV2, CABLE) inputs that have not been programmed with a setup code or Non-IR code are deleted from the cyclic list (except for the "AV AUX" VIDEO input). The PHONO input will be deleted if a Non-IR code was not registered.
- The **INPUT SELECTOR** on the front panel of the receiver always cycles through all inputs.



Although each setup code is designed to work with a number of different models, certain codes may not work with some models. (Also, certain codes may only operate some of the functions available on a given model.)

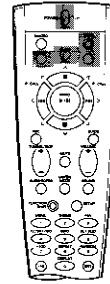

Keys or controls used in this operation.

Operating other components

This operation lets you operate the registered components.

KENWOOD audio components with system control turn on and off automatically with the receiver via the system control connections. -11

① Use the VIDEO, AUDIO, or TV keys to select the component you desire.



VIDEO



AUDIO



→



TV



② Press the SHIFT key and then press the POWER key (within 3 seconds).

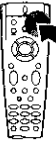

SHIFT



→



ER





1/0



③ Press the operation keys you desire.



BAND

- Pressing the **VIDEO** or **AUDIO** key also changes the input selector on the receiver. If you do not want to change the current input, press the **SHIFT** key before step ①. -35

VIDEO key

- ① VIDEO1 (VCR 1)
- ② VIDEO2 (VCR 2)
- ③ VIDEO3 (LD)
- ④ AV AUX

AUDIO key

- ① CD (CD)
- ② TAPE/MD (TAPE)
- ③ TUNER
- ④ PHONO

TV key

- ① TV1
- ② TV2
- ③ CABLE

- Pressing the **SHIFT** key is only required when turning the selected component on or off. Pressing the **POWER** key directly turns the receiver on and off.

- See "Remote operation of other components" at the end of this manual for a list of keys available with each component. -36

The remote control mode remains in the set at the component selected in step ① mode until you select another component (etc.)



Be sure to point the remote control at the remote sensor on the receiver when you want to operate KENWOOD components connected by system control cords. Otherwise, point the remote control at the component you want to operate.

This operation lets you change the remote control operation mode without changing the input selector.

You may find this useful when you want to control one component while using another. (For example, if you want to rewind the tape deck while listening to a CD.)

This operation is also useful if you don't know the which mode the remote control is set to. Executing this operation allows you to change or reconfirm the operation mode you desire.

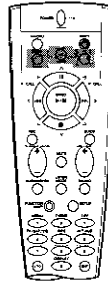

Keys or controls used in this operation.

Changing (confirming) the operation mode

1 Press **SHIFT**.

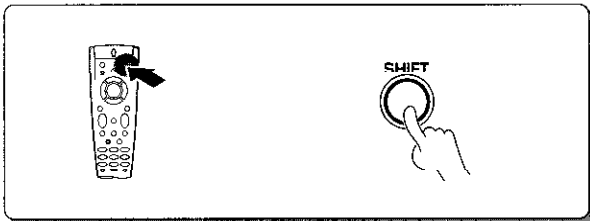

- To operate a TV, start from step 2.



Go to step 2 within 3 seconds.

2 Select the component to be controlled.

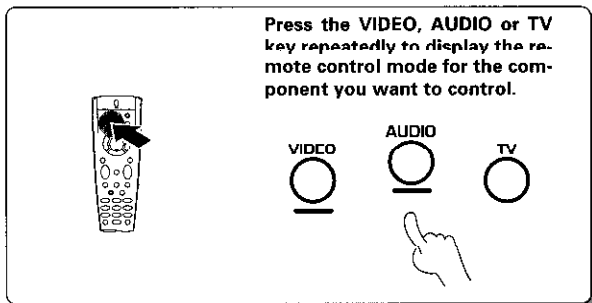

Press the **VIDEO**, **AUDIO** or **TV** key repeatedly to display the remote control mode for the component you want to control.

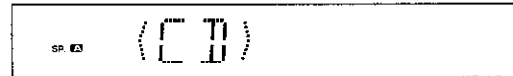

The component to be controlled is displayed in parenthesis.

- Pressing any other keys after the **SHIFT** key cancels the shift function and sends the normal code associated with the respective key.
- The input selector does not change during this operation.
- If you press **VIDEO** or **AUDIO** key more than 3 seconds after pressing the **SHIFT** key, the input selector changes together with the operation mode.

3 Execute the desired operations.

- See "Remote operation of other components" for a list of keys available with each component. - 49 -

The operation mode remains set at the component specified in step 2.

To return control to the original component, press **SHIFT** and then press the **VIDEO** or **AUDIO** key to return to the original control mode.

The macro play function allows you to set the remote to control several components in succession. After completing this setup, you can perform a series of operations automatically. Enter the setup codes for the components you want to control beforehand.

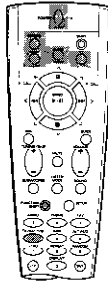

Keys or controls used in this operation.

Preparing for automatic operations (MACRO play)

1 Make a plan of the macro play you want to set up.

The order of the operations may be fairly complex and you may not be remember all of the necessary commands during the setup procedure. Use the space provided below to write down the operations in the order you are going to enter them.

①		⑪	
②		⑫	
③		⑬	
④		⑭	
⑤		⑮	
⑥		⑯	
⑦		⑰	
⑧		⑱	
⑨		⑲	
⑩		⑳	

- Up to 20 steps can be memorized for each macro.
- The example below shows the plan for step 4 (which occupies a total of 9 steps) :

1	TV + SHIFT + POWER	3 steps
2	FUNCTION SHIFT + 4	2 steps
3	VIDEO + VIDEO	2 steps
4	SHIFT + POWER	2 steps

Total 9 steps

- If you attempt to store more than 20 steps, the remote will output one long blink and exit the macro programming mode.
- Enter channel numbers (for the monitor TV, etc.) exactly as you would using the original remote.

2 Activate the macro program mode.

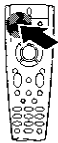

Press and hold the MACRO key until the backlight flashes twice.

MACRO



Perform each of the following steps within 5 seconds.

3 Select where the macro should be stored.

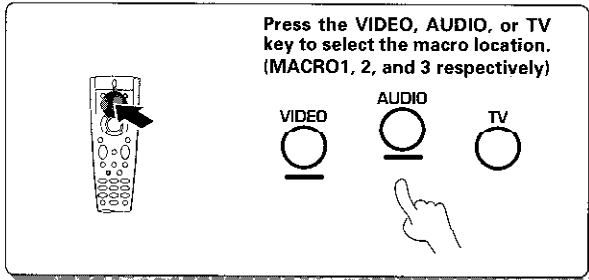

- You can store up to 3 different macros, one at each key: VIDEO → "MACRO 1", AUDIO → "MACRO 2", TV → "MACRO 3"
- The backlight flashes once when you select the macro location.
- Pressing a button other than VIDEO, AUDIO, or TV cancels the macro program mode.

When VIDEO is pressed



4 Press the keys to be operated in order.

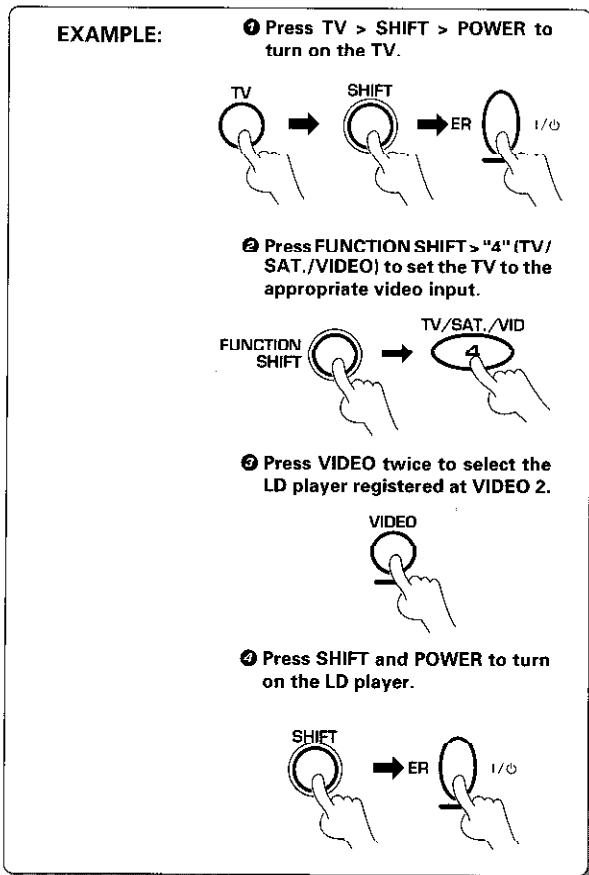

- This example shows you how to create a macro that: turns on the TV, sets the TV to the appropriate input, selects the receiver's input selector to LD, and turns on the LD player. All you have to do is insert the laser disc!
- In order to allow verification of the remote control mode, the name of the selected input appears in the receiver's display when the VIDEO, AUDIO or TV key is pressed. When the VIDEO or AUDIO key is pressed the receiver's input also changes.

5 Terminate the macro program mode.

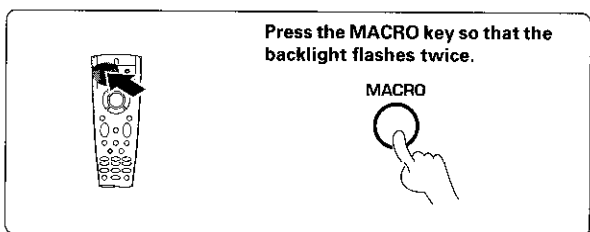

- The macro is stored at the locations specified in step 3. If another macro was previously stored at the same location, it is erased.

Repeat steps 3 through 5 to program up to 3 macros.

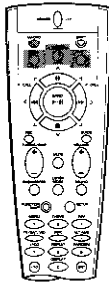

Keys or controls used in this operation.

Executing an automatic operation

1 Press the **MACRO** key.

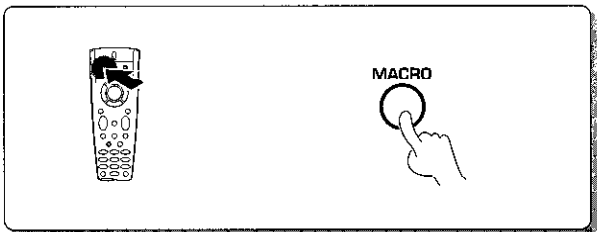

Go to step 2 within 3 seconds.

2 Execute the macro play.

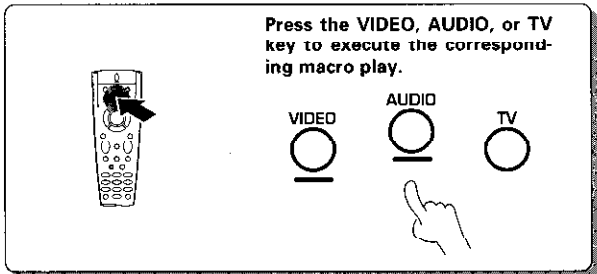

- "MACRO" appears in the front panel and on-screen display and the preprogrammed macro is performed:
VIDEO → "MACRO 1", **AUDIO** → "MACRO 2", **TV** → "MACRO 3"
- The remote control flashes once for each command output.
- Some devices take up to 1 second to power on. The macro function has an automatic delay after any power function output.
- Pressing a button other than **AUDIO**, **VIDEO**, or **TV** cancels the macro program mode.

When **VIDEO** is pressed



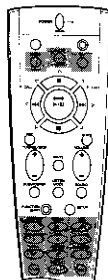

Keys or controls used in this operation.

Setup code correlation

Deleting a setup code

- ❶ Hold down the ENT key until the backlight flashes twice.
- ❷ Select the component to be deleted.
Press the VIDEO, AUDIO, or TV key repeatedly to select the desired component.
- ❸ Enter the 3 digit code "991".
- ❹ Hold down the ENT key until the backlight flashes twice.

- At this time all inputs become available regardless of any earlier registration.

- Example 1 : To delete the registration of the component connected to the VIDEO 1 jacks, select "VIDEO 1".



Perform each step within 5 seconds.

Checking a setup code

- ❶ Hold down the ENT key until the backlight flashes twice.
- ❷ Select the component with setup code you want to check.
Press the VIDEO, AUDIO, or TV key repeatedly to select the desired component.
- ❸ Enter the 3 digit code "000".
- ❹ Press the 1 key and count the number of times the backlight blinks. This is the first number of the 4 digit setup code.
- ❺ Press the 2 key and count the number of times the backlight blinks. This is the second number of the 4 digit setup code.
- ❻ Press the 3 key and count the number of times the backlight blinks. This is the third number of the 4 digit setup code.
- ❼ Press the 4 key and count the number of times the backlight blinks. This is the fourth number of the 4 digit setup code.

- The backlight flashes twice immediately after the "0" is input to confirm input.

- If the backlight does not blink, the first digit in the setup code is 0.

- If the backlight does not blink, the second digit in the setup code is 0.

- If the backlight does not blink, the third digit in the setup code is 0.

- If the backlight does not blink, the fourth digit in the setup code is 0.



Perform each step within 5 seconds.

FutureSet allows you to update the remote control so it can operate new components which do not appear in the setup code list at the end of the manual.

This function allows you to register new setup codes for any or all of the following command positions:

VIDEO1, VIDEO2, VIDEO3, TV1, TV2, CABLE, CD, TAPE/MD.

FutureSet codes are stored in memory. Each time a FutureSet upgrade is performed, any previous information in the FutureSet memory location is erased. Please inform your customer service representative if FutureSet has been previously used.

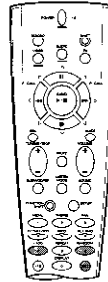

Keys or controls used in this operation.

FutureSet upgrade option (1070VR only)

- 1** Write down the brand name and model number of your component in the space provided before you call.
- 2** Call our Free-Phone Consumer Help-Line and explain which components you would like to add to your remote control.

USA: 1-800-753-9860
Canada: 1-800-644-0673

* This number is designed specifically for FutureSet upgrades, questions about system operation should be first addressed to your place of purchase.

- 3** Hold down the ENT key until the backlight flashes twice.

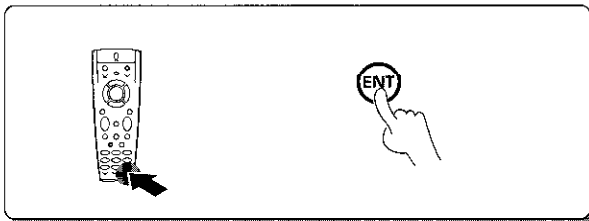

- 4** Enter the 3 digit code "997".

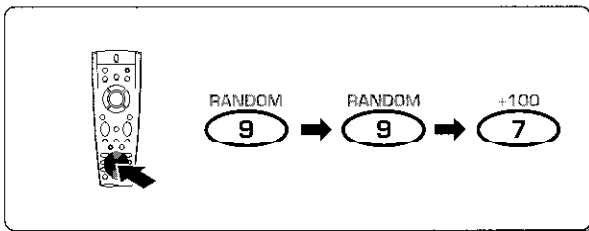

	Type	Brand	Model No.	Remote Model No.
	TV	KENWOOD	KV7-7777	RC-7777
1				
2				
3				

- After our customer service representative records the brand name and model number of your component, he/she will ask you to hold the remote to the speaker portion of your telephone as shown below. Your remote control is KENWOOD model number: RC-R0805
- The hours for customer service in USA and Canada currently are:

Monday-Thursday	9:00 am - 7:00 pm EST
Friday	9:00 am - 5:30 pm EST
Saturday	12:00 pm - 4:00 pm EST

Complete steps 3 and 4 before holding the remote to the speaker portion of your telephone.

- At this time all inputs become available regardless of any earlier registration.



Go to step 4 within 5 seconds.

- The backlight flashes twice.
- The remote is now in the upgrade mode. The remote will wait for 30 seconds for a valid telephone download signal. If nothing is received within this time, it will revert to normal operation.



Go to step 5 within 30 seconds.

- 5** Hold your remote to the speaker portion of your telephone.

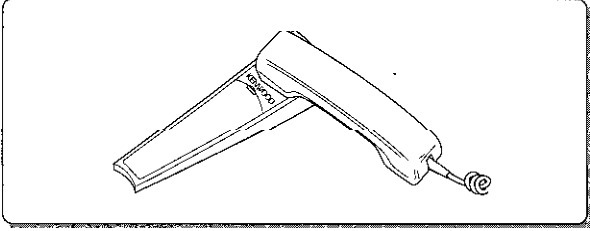

- For each setup code the operator can supply a setup code number. Should you ever need to change your input configuration, this number can be used. Please record for your future reference. If for some reason this information is lost, see "Checking a setup code" in the "Setup code correlation" section for further information.

Code selection after mode download

After successful completion of the download, step 5 above, the remote control automatically enters a special set-up mode which works as described below.

- 1** Select the component for which you want to register the information downloaded above.

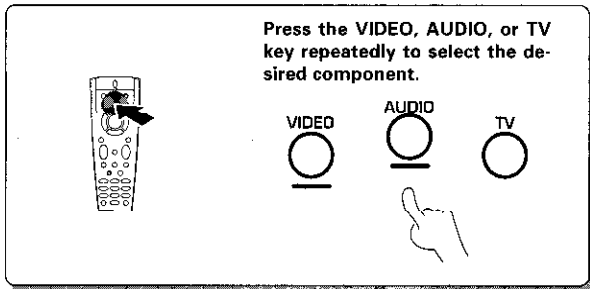

VIDEO key

- ① VIDEO1 (VCR 1)
- ② VIDEO2 (VCR 2)
- ③ VIDEO3 (LD)

AUDIO key

- ① CD (CD)
- ② TAPE/MD (TAPE)
- ③ PHONO

TV key

- ① TV1
- ② TV2
- ③ CABLE

- Example 1 : To register a code at the component connected to the VIDEO 1 jacks, select "VIDEO 1 (VCR)".



Perform each of the following steps within 5 seconds.

- 2** Press a numeric key.

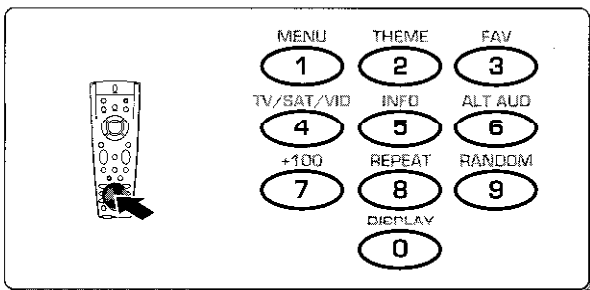

- 3** Repeat steps 1 and 2 to register all of the downloaded information.

- 4** Hold down the ENT key until the backlight flashes twice.

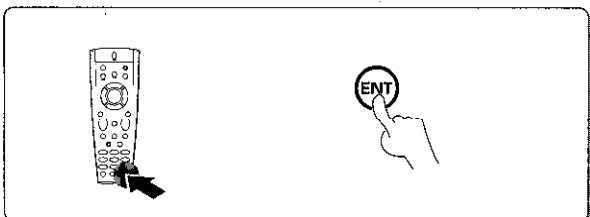

- Press the 1 key to output the POWER code of the first component on your list in step 2 of the previous page. Continue to push buttons 2 through 9 (and 0) until the component you want to register turns on.
- Though the FutureSet memory in your remote control is quite large, only 10 setup POWER codes can be put on the 10 keypad at any one time. If you require a larger download, the standard setup procedure can be used. See "Registering setup codes for other components", your customer service representative can supply you with the downloaded setup code numbers.

- The setup code for the last POWER code to be sent in step 2 is automatically registered at the location selected in step 1.

- At this time, the remote exits the special set-up mode and returns to its normal operation mode.

Non-IR codes

CD player	8900
Cassette deck	7900
LD player	5900
Phono	0900

Satellite	2900
TV	1900
VCR	4900

DVD	6900
DSS	3900
MD	8900

VCR Set up codes

Maker	Set up codes
Action	431 /
Adventura	4000
Aiko	4278
Aiwa	4000, 4307, 4406
Akai	4041, 4315
Akiba	4072
Alba	4278, 4296
American High	4035
Amstrad	4000
Anam	4162, 4240
Anam National	4162, 4454
Anitech	4072
ASA	4037, 4081
Asha	4240
Asuka	4037
Audiovox	4037
Baird	4000, 4041, 4104
Basic Line	4072, 4278
Beaumarck	4240
Bell & Howell	4104
Blaupunkt	4034, 4162
Brandt Electronic	4041
Broksonic	4121, 4184, 4211, 4295, 4361
Bush	4072, 4278
Calix	4037
Canon	4035
Carver	4081
CCE	4072, 4278
CGE	4000
Cimline	4072
Citizen	4037, 4278
Colt	4072
Craig	4037, 4047, 4072, 4240
Crown	4072, 4278
Curtis Mathes	4035, 4041, 4060
Cybernex	4240
Daewoo	4045, 4046, 4278
Dansai	4072

Maker	Set up codes
De Graaf	4042
Decca	4000, 4081
Dual	4041
Dumont	4000, 4081, 4104
Dynatech	4000
Elcatech	4072
Elootrohomo	4037
Electroponic	4037
Emerex	4032
Emerson	4000, 4002, 4037, 4043, 4121, 4184, 4211, 4278, 4295, 4361
ESC	4240, 4278
Ferguson	4041
Fidelity	4000
Finlandia	4081, 4104
Finlux	4000, 4042, 4081, 4104
Firstline	4037, 4043, 4045, 4072
Fisher	4046, 4047, 4066, 4104
Fuji	4033, 4035
Fujitsu	4000
Funai	4000
Garrard	4000
GE	4035, 4060
GEC	4081
Go Video	4232, 4350
GoldHand	4072
Goldstar	4037, 4038
Goodmans	4000, 4037, 4072, 4278
Gradiente	4000
Graetz	4041, 4104, 4240
Grenade	4046, 4081, 4104
Grandin	4000, 4037, 4072
Grundig	4034, 4072, 4081
Hanseatic	4037
Harley Davidson	4000

Maker	Set up codes
Harmon/Kardon	4038
Harwood	4072
HCM	4072
Headquarter	4046
Hi-Q	4047
Hinari	4072, 4240
Hitachi	4000, 4041, 4042, 4240
Hypson	4072
Imperial	4000
Interfunk	4081
ITT	4041, 4046, 4104, 4240
IIV	4037, 4278
Jensen	4041
JVC	4008, 4041, 4067
Kaisui	4072
KEC	4037, 4278
Kenwood	4038, 4041, 4067
KLH	4072
Kodack	4035, 4037
Korpel	4072
Lenco	4278
Leyco	4072
Lloyd	4000
Loewe	4037, 4081
Logik	4072, 4240
Luxor	4043, 4046, 4048, 4104
LXI	4037
M Electronic	4000
Magnavox	4035, 4039, 4081, 4149
Magnin	4240
Manesth	4045, 4072
Marantz	4035, 4081, 4295
Marta	4037
Matsui	4295
Matsushita	4035, 4162, 4454
MEI	4035

VCR Set up codes (continued)

Maker	Set up codes
Memorex	4000, 4035, 4037, 4039, 4046, 4047, 4048, 4104, 4240, 4307
Memphis	4072
Metz	4162, 4454
MGA	4043
MGN Technology	4240
Minolta	4042
Mitsubishi	4043, 4067, 4081, 4173
Muturula	4035, 4048
MTC	4000, 4240
Multitech	4000, 4072
Murphy	4000
NAD	4104
NEC	4038, 4041, 4067, 4104
Neckermann	4081
Nesco	4072
Nikko	4037
Nikon	4034
Noblex	4240
Nokia	4041, 4046, 4048, 4104, 4240
Nordmende	4041
Oceanic	4000, 4041
Okano	4315
Olympus	4035
Optimus	4037, 4048, 4104, 4162, 4454
Orion	4121, 4295
Osaki	4000, 4037, 4072
Otto Versand	4081
Palladium	4037, 4041, 4072
Panasonic	4035, 4077, 4162, 4454
Patho Marconi	4041
Penny	4035, 4037, 4038, 4042, 4240
Pentax	4042
Perdio	4000
Philco	4035, 4038
Philips	4035, 4081
Phonola	4081
Pilot	4037

Maker	Set up codes
Pioneer	4067, 4081
Profitronic	4240
Proline	4000
Protec	4072
Pulsar	4039
Pye	4081
Quarter	4046
Quartz	4046
Quasar	4035, 4077, 4162, 4454
Quelle	4081
Radio Shack	4000, 4037
Radiola	4081
Radix	4037
Randex	4037
RCA	4042, 4060, 4077, 4149, 4225
Realistic	4000, 4035, 4037, 4046, 4047, 4048, 4066, 4104, 4240
Rex	4041
Ricoh	4034
Roadstar	4037, 4072, 4240, 4278
Runco	4039
Saba	4041
Salora	4043, 4046
Samsung	4045, 4240
Sanky	4039, 4048
Sansui	4041, 4067
Sanyo	4046, 4047, 4104, 4240
SBR	4081
Schaub Lorentz	4000, 4041, 4104
Schneider	4000, 4072, 4081
Scott	4043, 4045, 4121, 4184, 4211
Sears	4035, 4037, 4042, 4046, 4047, 4066, 4104
SEG	4240
SEI	4081
Selco	4041
Sharp	4048
Shintom	4072, 4104
Shogun	4240
Siemens	4037, 4081, 4104

Maker	Set up codes
Silva	4037
Singer	4045, 4072
Sinudyne	4081
Sontec	4037
Sony	4032, 4033, 4034, 4035
STS	4042
Sunetar	4000
Suntronic	4000
Sylvania	4000, 4035, 4043, 4081
Symphonic	4000
Tandy	4000, 4104
Tashiko	4000
Tatung	4000, 4041, 4081
Teac	4000, 4041
Technics	4035, 4162
Teknika	4000, 4035, 4037
Teleavia	4041
Telefunken	4041
Tenusal	4072
Tensai	4000
Thomson	4041
Thorn	4011, 4104
TMK	4240
Toshiba	4041, 4043, 4045, 4060, 4066, 4081
Totevision	4037, 4240
Uher	4240
Unitech	4240
Universum	4000, 4037, 4081, 4240
Vector	4045
Vector Research	4030
Victor	4008, 4041, 4067
Video Concepts	4045
Videosonic	4240
Wards	4000, 4035, 4042, 4047, 4048, 4060, 4072, 4149, 4240
XR-1000	4000, 4035, 4072
Yamaha	4038
Yamishi	4072
Yokai	4072
Yoko	4240
Zenith	4033, 4034, 4039

TV Set up codes

Maker	Set up codes
Admiral	1003
Adventura	1046
Aiko	1092
Akai	1030
Alleron	1179
Ambassador	1177
Amstrad	1177
Anam	1180
Anam National	1055, 1250
AOC	1019, 1030, 1137
Audiovox	1180
Belcor	1019
Bell & Howell	1016, 1154
Blue Star	1282
BPL	1282
Bradford	1180
Brockwood	1019
Bush	1282
Candle	1030, 1046, 1056, 1186
Carnivale	1030
Carver	1054
Celebrity	1000
Citizen	1030, 1039, 1046, 1056, 1060, 1092, 1186, 1280
Concerto	1056
Contec	1180
Craig	1180
Crown	1039, 1180
Curtis Mathes	1030, 1039, 1060, 1154
CXC	1180
Daewoo	1019, 1039, 1092, 1154, 1451
Daytron	1019
Dumont	1017, 1019
Electroband	1000
Electrohome	1381
Emerson	1019, 1039, 1154, 1177, 1178, 1179, 1180, 1236, 1280, 1282, 1463
Envision	1030
Finlux	1179
Fisher	1154, 1159
Fortress	1093
Fujitsu	1179
Funai	1179, 1180
Futuretech	1180

Maker	Set up codes
GC	1021, 1027, 1047, 1051, 1055, 1135, 1178, 1282, 1451
General	1186
Gibralter	1017, 1019, 1030
Goldstar	1019, 1030, 1039, 1056, 1178
Goodmans	1179
Grandin	1282
Grunpy	1179, 1180
Hallmark	1179
Harvard	1180
HCM	1282
Hinari	1179
Hisawa	1282
Hitachi	1056, 1145, 1151
Hypson	1282
Infinity	1054
Janeil	1046
JBL	1054
JCB	1000
JVC	1053
Kaisui	1282
KEC	1180
Kenwood	1019, 1030
Kloss	1024, 1046
KTV	1030, 1039, 1180, 1280
Logik	1016
Luxman	1056
LXI	1047, 1054, 1154, 1156, 1178
Magnavox	1024, 1030, 1054, 1186, 1187
Majestic	1016
Marantz	1030, 1054
Matsui	1177
Matsushita	1250
Megatron	1145, 1178
Memorex	1016, 1056, 1150, 1154, 1178
MGA	1019, 1030, 1150, 1178
Midland	1017, 1039, 1047, 1051, 1135
Minutz	1021
Mitsubishi	1019, 1150, 1178
Motorola	1055, 1093
MTC	1019, 1030, 1056, 1060
Multitech	1180
NAD	1156, 1166, 1178

Maker	Set up codes
NEC	1019, 1030, 1050
Nesco	1179
Nikko	1030, 1092, 1178
Noshi	1018
NTC	1092
Onwa	1180
Optimus	1154, 1166, 1250
Optonica	1093, 1165
Orion	1177, 1236
Panasonic	1051, 1055, 1250
Penny	1018, 1019, 1021, 1027, 1030, 1039, 1047, 1051, 1060, 1135, 1156, 1178
Philco	1019, 1030, 1054
Philips	1054
Pilot	1019, 1030, 1039
Pioneer	1166
Portland	1019, 1039, 1092
Prism	1051
Proscan	1047
Proton	1031, 1178, 1466
Pulsar	1017, 1019
Quasar	1051, 1055, 1165, 1250
Radio Shack	1019, 1030, 1039, 1047, 1056, 1154, 1165, 1178, 1180
RCA	1018, 1019, 1047, 1090, 1135
Realistic	1019, 1030, 1039, 1056, 1154, 1165, 1178, 1180
Runco	1017, 1030
Saisho	1177
Sampo	1030, 1039
Samsung	1019, 1030, 1039, 1056, 1060, 1178, 1427
Samsux	1039
Sanyo	1154, 1159
Scimitsu	1019
Scotch	1178
Scott	1019, 1178, 1179, 1180, 1236
Sears	1047, 1054, 1056, 1154, 1156, 1159, 1178, 1179
SEI	1177
Sharp	1039, 1093, 1165
Shogun	1019
Signature	1016
Simpson	1186, 1187

TV Set up codes (continued)

Maker	Set up codes
Sinudyne	1177
Sony	1000
Soundesign	1178, 1179, 1180, 1186
Spectricon	1137
SSS	1019, 1180
Starlite	1180
Supra	1056
Supre-Macy	1046
Supreme	1000
Sylvania	1030, 1054, 1381
Tandy	1039, 1093

Maker	Set up codes
Tatung	1055
Technics	1051, 1250
Technol Ace	1179
Techwood	1051, 1056
Teknika	1016, 1019, 1039, 1054, 1056, 1060, 1092, 1150, 1179, 1180, 1186, 1312
Tera	1031
TMK	1056, 1177, 1178
Tomashi	1202
Toshiba	1060, 1154, 1156
Totevision	1039

Maker	Set up codes
Triumph	1111
Universal	1027
Vector Research	1030
Victor	1053, 1250
Vidikron	1054
Vidtech	1019, 1178
Viking	1046, 1312
Wards	1016, 1019, 1021, 1027, 1030, 1054, 1056, 1165, 1178, 1179
Yamaha	1019, 1030
Zenith	1016, 1017

Satellite Set up codes

Maker	Set up codes
Echostar	2280
General Instrument	2361

Maker	Set up codes
Jerrold	2361
Primostar	2361

Maker	Set up codes
Realistic	2052
Uniden	2052

LD player Set up codes

Maker	Set up codes
Carver	5194
Disco Vision	5023
Hitachi	5023
Kenwood	5258
Magnavox	5194
Marantz	5194

Maker	Set up codes
Mitsubishi	5059
NAD	5059
Panasonic	5204
Philips	5194
Pioneer	5023, 5059

Maker	Set up codes
Quasar	5204
Sega	5023
Sony	5201
Telefunken	5059
Theta Digital	5194

DSS Set up codes

Maker	Set up codes
Alphastar	3772
Echostar	3775
HTS	3775
Hughes Network Systems	3749

Maker	Set up codes
Jerrold	3627
Panasonic	3701
Primestar	3627

Maker	Set up codes
RCA	3566
Sony	3639
Toshiba	3790

DVD Set up codes

Maker	Set up codes
Panasonic	6400
Toshiba	6503

Cable Set up codes

Maker	Set up codes
ABC	0001, 0003, 0007, 0008, 0011, 0013, 0014, 0017
Antronix	0022
Archer	0022, 0153, 0797
Belcor	0056
Cable Star	0056
Cabletenna	0022
Cableview	0022
Century	0153
Citizen	0153
Colour Voice	0025
Comtronics	0040
Contec	0010
Daeryung	0008
Eastern	0002
Everquest	0015, 0040
Garrard	0153
GC Electronics	0056
Gemini	0015
General Instrument	0011, 0276, 0476
GoldStar	0040, 0144
Hamlin	0009, 0020, 0034, 0259

Maker	Set up codes
Hitachi	0011
Hytex	0007
Jasco	0153
Jerrold	0003, 0011, 0012, 0014, 0015, 0276, 0476
Memorex	0000
Movie Time	0063, 0156
NSC	0063, 0156
Oak	0007, 0019
Panasonic	0000, 0021, 0107
Paragon	0000
Philips	0025, 0153
Pioneer	0144, 0753
Prelude	0770
Pulsar	0000
PVP Stereo Visual Matrix	0003
Radio Shack	0797
RCA	0021
Regal	0020, 0259
Regency	0002
Rembrandt	0011
Runco	0000
Samsung	0040, 0144

Maker	Set up codes
Scientific Atlanta	0006, 0017, 0477
Signal	0015, 0040
Signature	0011
SL Marx	0040
Sprucer	0021
Starcom	0003, 0015
Stargate	0015, 0040, 0770
Starquest	0015
STS	0156
Sylvania	0001
Tandy	0258
Televue	0040
Texscan	0001
Tocom	0012, 0013
Toshiba	0000
Tusa	0015
IV86	0063
Unika	0022, 0153
United Artists	0007
United Cable	0003
Universal	0022, 0056, 0153
Viewstar	0063, 0258
Zenith	0000, 0625

CD Player Set up codes

Maker	Set up codes
Aiwa	8124, 8157
Arcam	8157
AudioTon	8157
California Audio Lab	8029
Carver	8157, 8179
Cyrus	8157
Denon	8003
DKK	8000
Dynamic Bass	8179
Elektra	8393
Emerson	8305
Fisher	8048, 8088, 8179
Garrard	8393
Genexxa	8032, 8305
Goodmans	8305
Grundig	8157
Hitachi	8032
JVC	8072, 8655
Kenwood	8028, 8037, 8048, 8099, 8190, 8858, 8859

Maker	Set up codes
Krell	8157
Linn	8157
LXI	8305
Magnavox	8157
Marantz	8029, 8157
Matsui	8157
MCS	8029
Memorex	8032, 8305
Meridian	8157
Micromega	8157
Mission	8157
NAD	8000
Naim	8157
NSM	8157
Onkyo	8101
Optimus	8000, 8032, 8037, 8179, 8305, 8468
Panasonic	8029, 8303
Philips	8157
Pioneer	8032, 8305, 8468
Proton	8157

Maker	Set up codes
QED	8157
Quad	8157
Quasar	8029
RCA	8053, 8179, 8305
Realistic	8179
Revox	8157
Rotel	8157
SAE	8157
Sansui	8157, 8305
Sanyo	8179
Scott	8305
Sears	8305
Sharp	8037
Sony	8000, 8185, 8604, 8605
Soundesign	8145
Tandy	8032
Teac	8393
Technics	8029, 8303
Universum	8157
Victor	8072
Yamaha	8036, 8187

DAT deck Set up codes

Maker	Set up codes
Carver	7158
Denon	7031
Grundig	7158

Maker	Set up codes
Marantz	7158
Philips	7158

Maker	Set up codes
Sony	7093
Technics	7158

Cassette deck Set up codes

Maker	Set up codes
Aiwa	7029, 7197
Arcam	7070
Carver	7029
Denon	7076
Fisher	7071
Garrard	7308, 7309
Grundig	7029
Inkel	7071

Maker	Set up codes
JVC	7244, 7273, 7274
Kenwood	7000, 7071, 7103
Magnavox	7029
Marantz	7009, 7029
Onkyo	7136
Optimus	7027, 7220
Panasonic	7229
Philips	7029
Pioneer	7027, 7220

Maker	Set up codes
Revox	7029
Sansui	7009, 7029
Sony	7170, 7243, 7291
Teac	7308, 7309
Technics	7229
Victor	7244, 7273, 7274
Wards	7027
Yamaha	7094, 7097

MD Set up codes

Maker	Set up codes
Kenwood	9000, 9826
Sony	9490

Misc. audio Set up codes

Maker	Set up codes
Jerrold	8459, 8520

Maker	Set up codes
Scientific Atlanta	8460

Maker	Set up codes
Starcom	8459

Resetting the Microcomputer

If the microcomputer may malfunction (unit cannot be operated, or shows an erroneous display) if the power cord is unplugged while the power is ON, or due to some other external factor. If this happens, execute the following procedure to reset the microcomputer and return the unit to its normal operating condition.

Unplug the power cord from the wall outlet, then plug it back in while holding down the POWER key.

- Please note that resetting the microcomputer will clear the contents of the memory and returns the unit to the state it was in when it left the factory.

Amplifier

Symptom	Cause	Remedy
No sound from the speakers.	<ul style="list-style-type: none"> • The speaker cords are disconnected. • VOLUME is set to the minimum position. • MUTE is ON. • The SPEAKERS switches are set to OFF. 	<ul style="list-style-type: none"> • Connect them properly referring to "Connecting the speakers" - [12] • Adjust the volume to a proper level. • Turn OFF the MUTE. - [19] • Set the SPEAKERS switch(es) to ON. - [18]
The standby indicator blinks and sound is not output.	<ul style="list-style-type: none"> • Speaker cords are short-circuited. 	<ul style="list-style-type: none"> • Turn the power off, eliminate the short-circuiting, then turn on the power again. - [12]
Sound is not output from one of the speakers.	<ul style="list-style-type: none"> • The speaker cord is disconnected. • The speaker balance is set to an extreme position. 	<ul style="list-style-type: none"> • Connect it properly referring to "Connecting the speakers". • Adjust the speaker levels using the test tone. - [15]
Sound is not output from the rear (surround) speakers and/or the center speaker, or their sound is very small.	<ul style="list-style-type: none"> • The rear speaker cords and/or the center speaker cord is disconnected. • A surround mode has not been engaged. • The rear and/or center volume controls are set to the minimum level. 	<ul style="list-style-type: none"> • Connect it properly referring to "Connecting the speakers". • Select a surround mode. • Adjust the speaker levels using the test tone. - [15]
A humming noise is generated when the PHONO input selector is selected.	<ul style="list-style-type: none"> • The audio cord from the turntable is not connected to the PHONO jacks. • The turntable is not grounded. 	<ul style="list-style-type: none"> • Insert the audio cord plugs securely into the PHONO jacks. • Connect the grounding wire to the GND terminal on the rear panel.

Tuner

Symptom	Cause	Remedy
Radio Stations cannot be received.	<ul style="list-style-type: none"> • No antenna is connected. • The broadcast band is not set properly. • The frequency of the desired station is not tuned. 	<ul style="list-style-type: none"> • Connect an antenna. • Set the broadcast band properly. • Tune the frequency of the desired station. - [23]
Interference.	<ul style="list-style-type: none"> • Noise due to ignition noise from an automobile. • Noise due to interference from an electric appliance. • Noise due to a nearby TV set. 	<ul style="list-style-type: none"> • Install the outdoor antenna away from the road. • Turn off the power to the appliance. • Install the receiver farther away from the TV.
A station which was preset cannot be received by pressing the corresponding numeric key.	<ul style="list-style-type: none"> • The preset station belongs to a frequency that cannot be received. • The preset memory was cleared because the power cord had been unplugged for a long period of time. 	<ul style="list-style-type: none"> • Preset a station with a receivable frequency. • Preset the station again.

Remote control unit

Symptom	Cause	Remedy
The backlight flashes five times during normal operation.	<ul style="list-style-type: none"> The batteries are nearing exhaustion. 	<ul style="list-style-type: none"> Replace with new batteries to preserve the currently registered setup information. → [18]
Subwoofer volume cannot be adjusted.	<ul style="list-style-type: none"> Subwoofer is OFF. 	<ul style="list-style-type: none"> Turn the subwoofer ON. → [14]
Certain inputs cannot be selected using the remote control.	<ul style="list-style-type: none"> No preset codes registered at for the respective input(s). 	<ul style="list-style-type: none"> Register a preset code or Non-IR code at the respective input(s). → [30]
Remote control operation is not possible.	<ul style="list-style-type: none"> The remote control is set to a different operation mode. Batteries are exhausted. The remote control unit is too far away from the main system, controlling angle is too large, or there is an obstacle between the receiver and the remote. The audio cords and system control cords are not connected properly. No software is loaded in the source component. An attempt is made to play a tape which is being recorded in the cassette deck. The remote control has not been set to the operation mode for the component you wish to control. 	<ul style="list-style-type: none"> Press VIDEO, AUDIO, or TV to select the appropriate operation mode. Replace with new batteries. If the backup is exhausted before you can replace the batteries, redo the setup procedure. → [18] → [30] Operate the remote control unit within the controllable range. Connect properly referring to "Setting up the system". → [28] Place software in the source component you want to play. Wait until recording has completed. Press the VIDEO, AUDIO, or TV key to activate the operation mode for the component you wish to control before operation. → [33]



Do not use contact cleaning agents because they could cause a malfunction. Be specifically careful against using contact cleaning agents containing oil, since they may deform the plastic components.

For the U.S.A.

FCC WARNING

This equipment may generate or use radio frequency energy. Changes or modifications to this equipment may cause harmful interference unless the modifications are expressly approved in the instruction manual. The user could lose the authority to operate this equipment if an unauthorized change or modification is made.

NOTE:

This equipment has been tested and found to comply with the limits for a Class B digital device, pursuant to Part 15 of the FCC Rules. These limits are designed to provide reasonable protection against harmful interference in a residential installation. This equipment may cause harmful interference to radio communications, if it is not installed and used in accordance with the instructions. However, there is no guarantee that interference will not occur in a particular installation. If this equipment does cause harmful interference to radio or television reception, which can be determined by turning the equipment off and on, the user is encouraged to try to correct the interference by one or more of the following measures:

- Reorient or relocate the receiving antenna.
- Increase the separation between the equipment and receiver.
- Connect the equipment into an outlet on a circuit different from that to which the receiver is connected.
- Consult the dealer or an experienced radio / TV technician for help.

Memory back up function

Please note that the following items will be deleted from the unit's memory if the power cord is disconnected from the AC outlet for approximately 3 days.

- Power mode.
- Settings made (like SURROUND SET UP).
- Input selector settings.
- Volume level.
- Broadcast band.
- Frequency setting.
- Preset stations.

For the U.S.A.

Note to CATV system installer:

This reminder is provided to call the CATV system installer's attention to Article 820-40 of the NEC that provides guidelines for proper grounding and, in particular, specifies that the cable ground shall be connected to the grounding system of the building, as close to the point of cable entry as practical.

Specifications

Kenwood - Read this page carefully to ensure safe operation.

1070VR/1060VR (En/K)

AUDIO section

Rated power output during STEREO operation

(1070VR)

120 watts per channel minimum RMS, both channels driven, at 8 Ω from 20 Hz to 20 kHz with no more than 0.06 % total harmonic distortion.(FTC)

(1060VR)

110 watts per channel minimum RMS, both channels driven, at 8 Ω from 20 Hz to 20 kHz with no more than 0.06 % total harmonic distortion.(FTC)

Rated power output during SURROUND operation

(1070VR)

FRONT

(1kHz, 0.7% T.H.D. at 8 Ω) 120 W + 120 W

CENTER

(1kHz, 0.7% T.H.D. at 8 Ω) 120 W

SURROUND

(1kHz, 0.7% T.H.D. at 8 Ω) 60 W + 60 W

(1060VR)

FRONT

(1kHz, 0.7% T.H.D. at 8 Ω) 110 W + 110 W

CENTER

(1kHz, 0.7% T.H.D. at 8 Ω) 110 W

SURROUND

(1kHz, 0.7% T.H.D. at 8 Ω) 110 W

Total harmonic distortion

(1070VR) 0.015%(1 kHz, 60W, 8 Ω)

(1060VR) 0.015%(1 kHz, 55W, 8 Ω)

Frequency response

CD 5 Hz - 85 kHz, +0.5 dB, -3 dB

Signal to noise ratio (IHF'66)

PHONO (MM) 75 dB

CD 95 dB

Input sensitivity / impedance

PHONO (MM) 2.5 mV / 47 k Ω

CD 200 mV / 47 k Ω

ADAPTOR IN 400 mV / 10 k Ω

Output level / impedance

TAPE REC 200 mV / 1 k Ω

ADAPTOR OUT 200 mV / 1 k Ω

PRE OUT (CENTER, SURROUND) 1 V / 600 Ω

PRE OUT (SUBWOOFER) 1 V / 1 k Ω

Tone control

BASS ± 8 dB (at 100 Hz)

TREBLE ± 8 dB (at 10 kHz)

LOUDNESS control

VOLUME at -40dB level ... +7 dB(100 Hz), +3 dB(10 kHz)

VIDEO section

VIDEO inputs / outputs

VIDEO (composite) 1 Vp-p / 75 Ω

FM tuner section

Tuning frequency range 87.5 MHz ~ 108 MHz

Usable sensitivity (MONO)

..... 1.6 μ V (75 Ω) / 15.2 dBf (75 kHz DEV., SINAD 30 dB)

50dB quieting sensitivity

STEREO 31.6 μ V (75 Ω) / 41.2 dBf

Total harmonic distortion (1 kHz)

(for U.S.A. and Canada)

MONO 0.2 % (65 dBf input)

STEREO 0.5 % (65 dBf input)

(except for U.S.A. and Canada)

MONO 0.6 % (65 dBf input)

STEREO 0.7 % (65 dBf input)

Signal to noise ratio (1 kHz, 75 kHz DEV.)

MONO 75 dB (65 dBf input)

STEREO 68 dB (65 dBf input)

Stereo separation (1 kHz)

..... 40 dB

Selectivity (± 400 kHz)

(for U.S.A. and Canada) 70 dB

(except for U.S.A. and Canada) 50 dB

Frequency response 30 Hz ~ 15kHz,+0.5 dB, -3.0 dB

AM tuner section

Tuning frequency range (for U.S.A. and Canada)

10 kHz step 530 kHz ~ 1.700 kHz

Tuning frequency range (except for U.S.A. and Canada)

9 kHz step 531 kHz ~ 1.602 kHz

10 kHz step 530 kHz ~ 1.610 kHz

Usable sensitivity (30% mod., S/N 20 dB)

..... 16 μ V / (600 μ V/m)

Signal to noise ratio (30 % mod., 1 mV input) 48 dB

GENERAL

Power consumption

(1070VR) 2.9 A

(1060VR) 2.5 A

AC outlet

SWITCHED 2 (total 100 W, 0.83 A max.)

Dimensions W : 440 mm (17-5/16")

..... H : 147 mm (5-13/16")

..... D : 392 mm (15-7/16")

Weight (Net)

(1070VR) 11 kg (24.3 lb)

(1060VR) 10 kg (22.0 lb)



KENWOOD follows a policy of continuous advancements in development. For this reason specifications may be changed without notice.

Remote operation of other components

Refer to the following for the type of remote control operations available for each component. The setup code for each component must be entered beforehand.

- 1 Use the **AUDIO**, **VIDEO**, or **TV** keys to select the component you want to control.
- 2 Press the keys corresponding to the operations you desire. Refer to the following sections for details.

- When pressing keys in succession, press each key firmly and be sure to wait at least 1 second before pressing the next key.
- Numeric keys function the same as the numeric keys on the original remote.
- To execute a **FUNCTION SHIFT** command, press the **FUNCTION SHIFT** key, then press the corresponding key within 3 seconds.



1. Although each setup code is designed to work with a number of different models, certain codes may not work with some models. (Also, certain codes may only operate some of the functions available on a given model.)
2. The charts below show the typical functions available for each component. Some manufacturers use different key combinations to perform similar functions. For that reason, we have programmed extra functions on some of the unused number keys to help you control your equipment. To find if your component has extra functions, press the **FUNCTION SHIFT** key, then press a number key. Repeat this procedure for each number key.

Tuner operations

TUNING/SKIP



TUNING - [23]

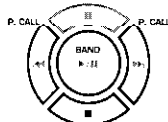

- ▶/|| (BAND - [23])
- (AUTO - [23])
- ◀◀ (P.CALL - [26])
- ▶▶ (P.CALL + - [25])

FUNCTION SHIFT

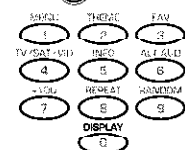

FUNCTION SHIFT commands
DISPLAY (Dimmer - [27])

Cassette deck operations

TUNING/SKIP



+ (▶ Play)
- (◀ Play)



(● Record)

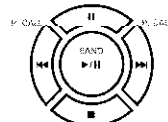

- ▶/|| (▶ Play)
- (Pause)
- ◀◀ (◀◀ Rewind)
- ▶▶ (▶▶ Fast forward)

CD player operations

TUNING/SKIP



+ (Disc Skip +)
- (Disc Skip -)

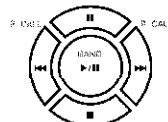

- ▶/|| (Play/Pause (for SL16))
- ▶/|| (▶ Play (for other))
- || (Pause (for other))
- (Stop)
- ◀◀ (Skip)
- ▶▶ (Skip)

FUNCTION SHIFT

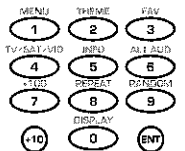

Numeric keys

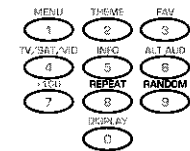

FUNCTION SHIFT commands
REPEAT (Repeat)
RANDOM (Random)
DISPLAY (Dimmer)

MD recorder operations

TUNING/SKIP



+ (▶▶ Search)
- (◀◀ Search)

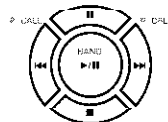

- ▶/|| (▶ Play)
- || (Pause)
- (Stop)
- ◀◀ (Skip back)
- ▶▶ (Skip forward)



Numeric keys

FUNCTION SHIFT

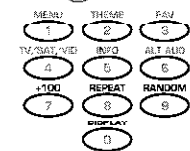

FUNCTION SHIFT commands
+100 (+100)
REPEAT (Repeat)
RANDOM (Random)
DISPLAY (Dimmer)

TV operations

TUNING/SKIP



+ (Channel +)
- (Channel -)

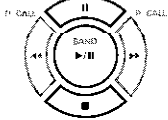

▶/|| (Mute)
|| (Volume +)
■ (Volume -)

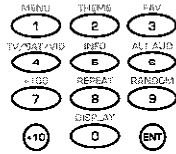

Numeric keys

FUNCTION SHIFT

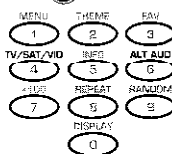

FUNCTION SHIFT commands
TV/SAT./VID (Input selector)
ALT AUDIO (Alternate audio)

VCR operations

TUNING/SKIP



+ (Channel +)
- (Channel -)

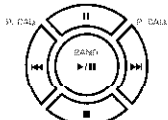

▶/|| (▶ Play)
|| (Pause)
■ (Stop)
◀◀ (◀◀ Rewind)
▶▶ (▶▶ Fast forward)

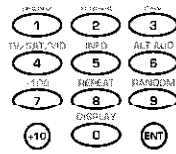

Numeric keys

FUNCTION SHIFT



FUNCTION SHIFT commands
TV/SAT./VID (Input selector)

REC
(● Record)
GUIDE
(OSD menu)

LD player operations

TUNING/SKIP



+ (A, A/B)
- (B)

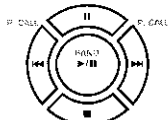

▶/|| (▶ Play)
|| (Pause)
■ (Stop)
◀◀ (Skip back)
▶▶ (Skip forward)

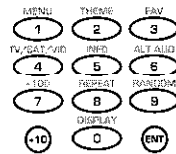

Numeric keys

FUNCTION SHIFT

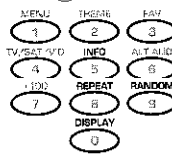

FUNCTION SHIFT commands
INFO (Frame-time)
REPEAT (Repeat)
RANDOM (Random)
DISPLAY (Display)

GUIDE
(OSD menu)

Satellite tuner operations

TUNING/SKIP



+ (Channel +)
- (Channel -)

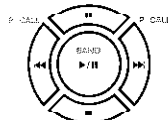

▶/|| (Select)
|| (↑)
■ (↓)
◀◀ (←)
▶▶ (→)

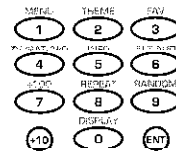

Numeric keys

FUNCTION SHIFT

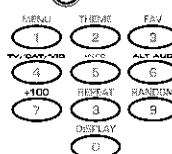

FUNCTION SHIFT commands
TV/SAT./VID (Input selector)
ALT AUDIO (Alternate audio)
+100 (+100)

GUIDE
(OSD menu)

DSS receiver operations

TUNING/SKIP



+ (Channel +)
- (Channel -)

P. CALL

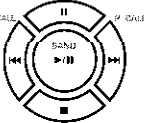

▶/|| (Select)
|| (↑)
■ (↓)
◀◀ (←)
▶▶ (→)

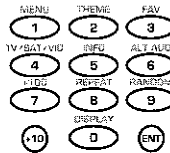
**Numeric keys**

FUNCTION SHIFT

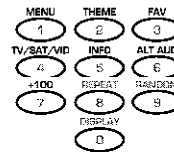
**FUNCTION SHIFT commands**

MENU (Menu)
THEME (Theme)
FAV. (Favorite)
TV/SAT./VID (Input selector)
INFO (Information)
ALT AUDIO (Alternate audio)
+100 (+100)

GUIDE



(CH Guide)

Cable tuner operations

TUNING/SKIP



+ (Channel +)
- (Channel -)

P. CALL

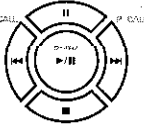

▶/|| (Select)
|| (↑)
■ (↓)
◀◀ (←)
▶▶ (→)

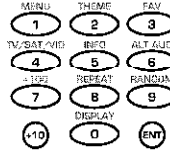
**Numeric keys**

FUNCTION SHIFT

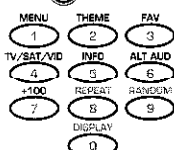
**FUNCTION SHIFT commands**

MENU (Menu)
THEME (Theme)
FAV. (Favorite)
TV/SAT./VID (Input selector)
INFO (Page)
ALT AUDIO (Alternate audio)
+100 (+100)

GUIDE



(OSD menu)

DVD player operations

TUNING/SKIP



+ (Disc skip +)
- (Disc skip -)

P. CALL

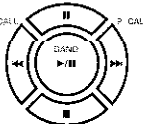

▶/|| (▶ Play)
|| (Pause)
■ (Stop)
◀◀ (Skip back)
▶▶ (Skip forward)

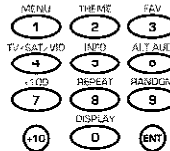
**Numeric keys**

FUNCTION SHIFT

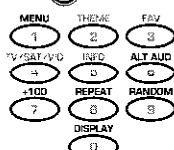
**FUNCTION SHIFT commands**

ALT AUDIO (Alternate audio)
+100 (+100)
REPEAT (Repeat)
RANDOM (Random)
DISPLAY (Display)

REC



(● Record)

GUIDE



(OSD menu)

KENWOOD

For your records

Record the serial number, found on the back of the unit, in the spaces designated on the warranty card, and in the space provided below. Refer to the model and serial numbers whenever you call upon your dealer for information or service on this product.

Model _____ Serial Number _____